



### Welcome!

This owners manual is written in easy english and uses a lot of drawings to simply the installation and use of the above amplifiers.

Your DLS amplifiers must be installed correctly to perform at its best . This manual will show you how to install the amplifier like a pro. Please read the entire manual before beginning the installation. Install the amplifier yourself if you feel confident with our instructions and if you have the proper tools. However if you feel unsure, turn over the installation job to someone better suited to it.

### Warranty Service

This amplifier is covered by warranty, depending on the conditions in the country where it is sold. If the amplifier is returned for service, please include the original dated receipt with the product.

### Technical Assistance

For technical assistance ask the shop where the product was sold or the distributor in your very country. Information can also be found on our WEB-site [www.dls.se](http://www.dls.se)

We follow a policy of continuous advancement in development. For this reason all or part of specifications & designs may be changed without prior notice.

### DECLARATION OF CONFORMITY

DLS amplifiers for vehicles are manufactured in accordance with the EU directive EEC 95/54 (72/245/EEC) and are marked with the approval number. They are also marked in accordance with the WEEE-directive 2002/96/EC.

The products are also produced in accordance with the EU RoHS directive 2002/95/EC.

How to install and operate the DLS amplifier models

# CCI2 CCI4 / CCI44 CCI500 / CCI1000

## Contents

Features.....	2
Installation.....	2
Routing Wires.....	2
Tools and materials needed.....	3
<b>Wiring &amp; crossovers:</b>	
Power and remote wiring.....	3-4
Low & High level input wiring .....	4
Input level control, BASS EQ, etc .....	5
Features on each model .....	5
<b>CCI500 / CCI1000 speaker wiring:</b>	
One or more subwoofers.....	6
<b>CCI2 speaker wiring:</b>	
Front speakers.....	7
Subwoofer.....	7
<b>CCI4 / CCI44 speaker wiring:</b>	
Four speakers.....	8
Two speakers and bridged subwoofer.....	8
Two subwoofers or a stereo speaker pair connected in bridge mode .....	9
Testing.....	10
Troubleshooting.....	10
Professional tips.....	11
Specifications.....	12



This product must be returned to the separate collection system for electronic products. Do not dispose this product together with general household waste.

DLS amplifiers are designed and engineered by:

**DLS Svenska AB**

P.O. Box 13029 - SE-40251 Göteborg - Sweden

Tel: +46 31 840060 - Fax: +46 31 844021

E-mail: [info@dls.se](mailto:info@dls.se)

[www.dls.se](http://www.dls.se)

Sound tuned in England.



The models include the following features:

- Analogue class AB or D technique
- High efficiency
- Low profile design
- RCA line inputs
- High level input with auto start
- Powerful DC cable terminals
- Built-in active crossovers
- Remote sub level control on CCi500 / CCi1000

# Installation

## Before you begin installation

Before you begin you need to read the manual, to have some tools, cables and other material available. There is one such list of material on the following page.

## Amplifier location

### Important

Allow air circulation around the amplifier.

The DLS series of amplifiers have a compact design that allows great flexibility in mounting. You can mount it under a seat or in the trunk. When you select a location, do remember that the amplifier generates a lot of heat.

Choose a location where air can circulate freely around the amplifier. Do not cover the amplifier with carpets or hide behind trim panels. Do not mount the amplifier in an inverted or upside down position.

Check all locations and placements carefully before making any cuts, drilling any holes or making any connections.

### IMPORTANT!

**Use the metal screws coming with the amplifier when you do the install. Do not use oversized screws.**

## Disconnect Battery

Before starting the installation, always disconnect the negative terminal of the battery.

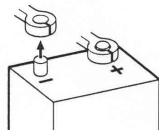

## Routing wires

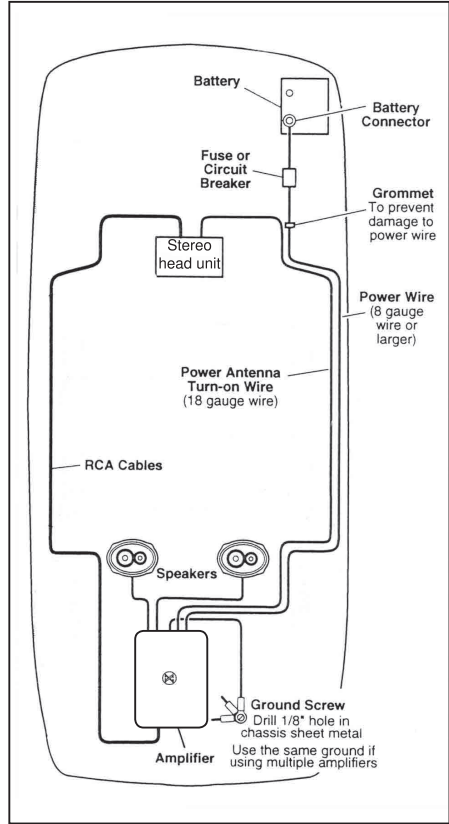

## Professional Tip:

If amplifier installation kits are available with different size of power cable, chose the most heavy power cable to improve sound quality and to allow more amplifiers to be installed now or later. The amplifier power terminals on CCi2, CCi4 & CCi44 accept AWG 5 cables, so if possible buy AWG 5 = 16 mm<sup>2</sup> cable for best performance. CCi500 & CCi1000 accepts AWG 2 = 33 mm<sup>2</sup> power cable. Both the positive wire and the ground wire must have the same size.

### NOTE!

**To avoid cable fire, be sure not to oversize the main fuse value for the power wires.**

### THE DC-FEED

Maximum main fuse values for different cable sizes.

6 mm <sup>2</sup> (9 AWG)	:25 A	10 mm <sup>2</sup> (7AWG)	: 40 A
16 mm <sup>2</sup> (5AWG)	:60 A	21 mm <sup>2</sup> (4AWG)	: 100 A
33 mm <sup>2</sup> (2AWG)	:150 A	42 mm <sup>2</sup> (1AWG)	: 200 A



# Power wiring

## Tools and material needed

### Tools:

- Flat and Phillips screwdrivers
- Wire cutter
- Wire stripper
- Electric drill with drills
- Crimping tool
- Digital multimeter or test lamp
- Wire brush, scraper or a piece of an abrasive sheet to remove paint for a good ground connection
- Grease to protect the ground connection from oxidation

### Material:

- Speaker wire: minimum 12 AWG = 4 mm<sup>2</sup> for subwoofers connected to CCI500 / CCI1000  
13 – 16 AWG = 1,5 - 2,5 mm<sup>2</sup> for other speakers
- Sheet metal screws for mounting the amplifier to the amplifier board and the amplifier board to the car + some extra for fuse holder, amplifier ground etc.
- Electrical insulation tape
- ½ inch thick plywood or particle board for the amplifier to be mounted upon.

### Amplifier installation kit:

If available, buy an amplifier installation kit. It contains normally all you need. This is what you have to buy if you buy the items separately

- 20- 25 feet = 6-7.5 meter power cable, minimum AWG 8 = 10 mm<sup>2</sup> or heavier
- 1 pc of fuseholder to install close to the car battery + fuse (see below)
- 20 feet of AWG 15 = 1,5 mm<sup>2</sup> wire for remote turn on / off cable from radio.
- RCA-cable for input from radio.
- - 20 feet or 5 meter for trunk installations
- -12 feet or 2 – 3 meter for under seat installations
- Two ring crimp terminals, —one for connection to the battery plus and one for the amplifier ground connection.
- Four to eight splicers to connect speaker cables to high level input cable, if high level input is used.
- Wire ties
- Insulating grommet or insulating tube

## Fuses

There are no internal fuses in the amplifiers so we recommend the use of an external fuse holder.

### Fuse values:

- CCI2 and CCI4 : 40 A
- CCI44 and CCI500 : 60 A
- CCI1000 : 100 A

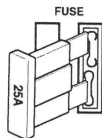

## Power terminal ( +12V)

Connect the fuse holder as close to the vehicle battery + as possible, using AWG 4 / 5 = 21 / 16 mm<sup>2</sup> power cable. Use a ring crimp terminal to connect to battery. The AWG4 cable can use an 80 Amp fuse, if the cable is smaller, the fuse value must be lower (see table on previous page). This fuse is to protect from cable fire!

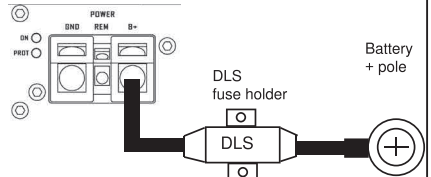

Be sure to use a rubber grommet or a plastic insulating tube where the cable passes the firewall or other places where it can be easily jammed. Use wire ties to secure to existing cables in the engine compartment.

## Ground Terminal ( GND )

Connect to a good chassis ground. The ground connection should be clean, unpainted metal to provide a good electrical connection. Use a wire brush, a scraper or a piece of an abrasive sheet to clean the metal. Use a lock washer or two to secure contact. Protect with silicon grease or by paint applied afterwards.

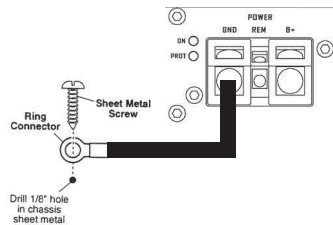

## Power Light / Protect light

The power indicator (green) is lit when the amplifier is turned on.

- Power (Green)
  - Protect (Red)
- The protect indicator (red) is lit when the amplifier shuts down from over-heating, or a short circuit (speaker failure). Turn off your audio system to reset the amplifier if the red protect light is turned on. If the red lamp doesn't turn off, contact your local dealer for advice.



## Remote terminal ( REM )

### For RCA cable signal input:

Connect the radio power antenna lead = remote turn on/off from the car stereo to the amplifier remote connection. This turns on the amplifier whenever the car stereo is turned on. You can either use the built in remote cable in the RCA cable itself or use a separate cable.

Sometimes a small disturbance may enter the amplifier coming from the remote voltage, through the built in remote wire and into the RCA cable. Thus we recommend to use a separate remote wire and run the RCA lead separate from remote wire, power cables and speaker cables.

If there is no remote voltage available from the stereo, you must connect to the ignition key through the radio or any accessories fuse.

When high level input is used the amplifier starts automatically when your car stereo is switched on.

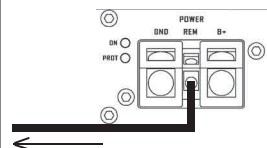

To head unit Power Antenna lead or remote output. A cable up to AWG 14 (2,5 sq mm) fits the amplifier remote (REM) terminal.

## Low level Input Wiring

Inputs may be low level from the RCA output of the car stereo or high level from the car stereo speaker output. Low level = RCA is to prefer for the best sound quality.

### Important

Use either the low level or high level input, do not use both at same time.

### Low level input

Use a pair of shielded stereo audio cables with RCA type jack. Most trunk-mount amplifiers need a 20 feet RCA cable ( appr 5 – 6 meters).

Connect to input socket **CH1 / CH2 on Cci2.**

Or **R/ L on Cci500 / Cci1000.**

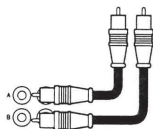

**CCi4 / Cci44** has dual inputs **CH1 / CH2 / CH3 / CH4** Depending on your chosen configuration you can use either two separate RCA cables, or a single RCA cable together with an Y-split to connect both inputs.

## High Level Input wiring

### For High Level input:

Most headunits are pre-installed from the car factory and have no RCA output, in this case you can take the signal from the speaker output instead.

Use either a separate remote cable or let the high level signal automatically start the amplifier.

Connect left and right speaker wires coming from the car stereo to the high level input as shown. You must connect both plus and minus as the inputs are balanced, connecting plus only gives lower level and bad sound quality. By changing the polarity of plus and minus, you can change the phase.

### CCi500 / CCi1000 / CCi2

On these two models you connect as in this example: CCi500 / CCi1000 are marked R and L instead of CH1 / CH2.



Hi level input plug.

### CCi4 / Cci44

The four channel amplifier is connected likewise, however we have four channels.

You can feed two channels from RCA and two channels using high level input from rear speaker cables, or all channels from high level input.



Hi level input plug.

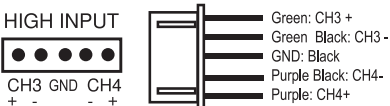

Hi level input plug.



## Input Level control - GAIN

The GAIN control, MIN – MAX, matches the output of your radio to the input of the amplifier. After installation is complete, make sure the input of the amplifier is turned down all the way to MIN. After turning the head unit ON, you can adjust the GAIN level, A normal setting is from 12 - 14 o' clock.

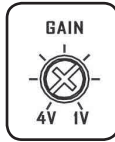

## High Pass filter (HPF) - CCI2 / CCI4 / CCI44

The high pass filter blocks very low frequencies from reaching the speakers, mostly used to protect small speakers from deep bass.

Set the push button to **ON** and the **HPF / LPF** button to **HPF (button OUT)** to activate the filter, or **OFF** if you want to run the amplifier in full range mode without limiting the frequency range.

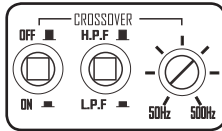

## Low Pass filter (LPF) - CCI2 / CCI4 / CCI44

The low pass filter is mostly used for subwoofers. It will allow low frequencies only and blocks higher frequencies. A typical setting is 60 – 70 Hz.

Set the push button to **ON** and the **HPF / LPF** button to **LPF (button IN)** to activate the filter, or **OFF** if you want to run the amplifier in full range mode without limiting the frequency range.

The **CCI4 / CCI44** model have the same setup of filters on channels 1 & 2 and 3 & 4 as well.

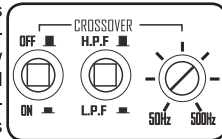

## Low Pass filter (LPF) / Phase shift

The low pass filter is mostly used for subwoofers. It will allow low frequencies only and blocks higher frequencies. A typical setting is 60 – 70 Hz.

The **LPF** filter has two selectable slopes 12 or 24 dB, choose the slope that sounds best in your installation.

### Phase switch - CCI500 / CCI1000

To get the best possible front stage from your subwoofer installation you can choose the phase shift between **0 (button OUT)** or **180 degrees (button IN)**. Listen to the bass and choose the position that gives the best front stage in your vehicle.

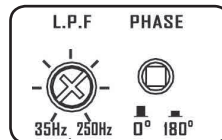

## Bass EQ CCI2 / CCI500 / CCI1000

**Bass EQ** or Bass boost is used to increase the bass volume at a specific frequency (60 Hz). You can adjust the amplification continuously from 0 dB ( no amplification ) to + 6 dB.

This function is used to compensate for the bass box function and to adjust for your own taste of bass. Set level control at 0 dB if you want it to be inoperative.



## Subsonic filter on CCI500 / CCI1000

The subsonic filter reduces the lowest frequencies below 30 Hz. In **ON**-position the bass sound becomes more tight.

Choose the position that best suits your ears and the installation.



## Features on each model

The **CCI500 / CCI1000** are 1-channel mono amplifiers.

Can be used for one or more subwoofers

**The amplifiers have the following filters / features:**

- Lowpass filter adjustable from 35 to 250 Hz
- Remote level control.
- Phase switch 0 - 180 degrees
- Subsonic filter
- Selectable LPF slopes 12 / 24 dB
- Bass EQ 0 - + 6 dB adjustable

The **CCI2** is a 2-channel amplifier.

Can be used for a pair of stereo speakers or a subwoofer connected in mono bridge mode.

**The amplifier has the following filters / features:**

- Lowpass filter adjustable from 50 to 500 Hz, the filter can be switched off.
- Highpass filter adjustable from 50 to 500 Hz, the filter can be switched off.
- Bass EQ 0 - + 6 dB adjustable

The **CCI4 / CCI44** are 4-channel amplifiers for use with a front speaker and a subwoofer, or two speaker pairs in front and rear.

**The amplifier has the following filters / features:**

- Lowpass filter adjustable from 50 to 500 Hz, the filter can be switched off.
- Highpass filter adjustable from 50 to 500 Hz, the filter can be switched off.

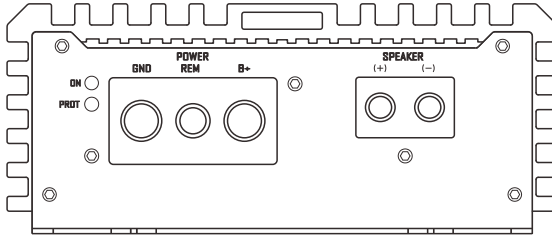

### Speaker wiring CCi500 / CCi1000

#### Two 4 ohm subwoofers

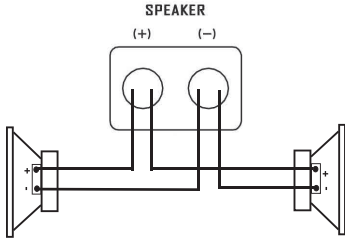

**NOTE!**

Two 4 ohm subwoofers gives a 2 ohm load when connected in this way. Minimum amplifier load is 1 ohm, lower impedances may damage the amplifier.

#### Filter settings Low Pass filter

The low pass filter is mostly used for subwoofers. It will allow low frequencies only and blocks higher frequencies. A typical setting is 60 – 70 Hz.

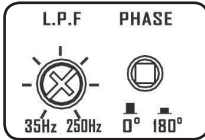

The L.P.F filter has two selectable slopes 12 or 24 dB, choose the slope that sounds best in your installation.



#### Phase switch - CCi500 / CCi1000

To get the best possible front stage from your subwoofer installation you can choose the phase shift between 0 (button OUT) or 180 degrees (button IN)

Listen to the bass and choose the position that gives the best front stage in your vehicle.

#### One 4 ohm or 2 ohm subwoofer

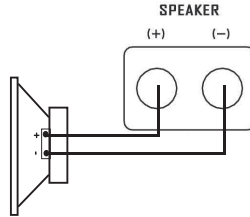

**NOTE!**

Subwoofer impedance can be 4 ohm or 2 ohm. Minimum amplifier load is 1 ohm, lower impedances may damage the amplifier.

#### CONNECTIONS IN SERIES OR PARALLEL

Subwoofers with dual voice coils, or any subwoofer, can be connected in series or in parallel for various impedances but **the resulting impedance must never be lower than 1 ohm.**

#### Remote sub level control

You can adjust the bass sound level from the front seat of your car if you connect the external sub level control box. The external remote works together with the internal gain control, the setting of the internal gain decides the maximum level also for the external level control.

Connect to **REMOTE** socket on CCi500 / CCi1000.

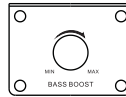

For power wiring, see page 3-4  
For high or low level input wiring, see page 4  
For Bass boost and subsonic control, see page 5

### CCi500 / CCi1000

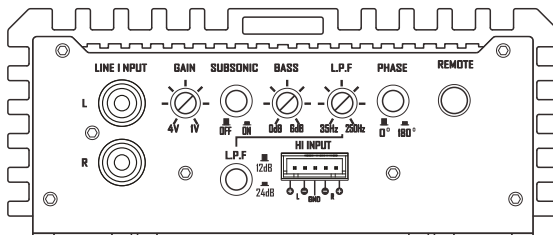

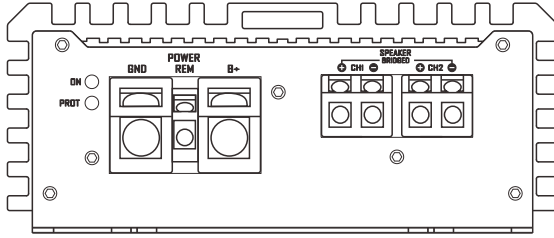

### Speaker wiring CCi2

#### Two fullrange speakers to channel 1 / 2

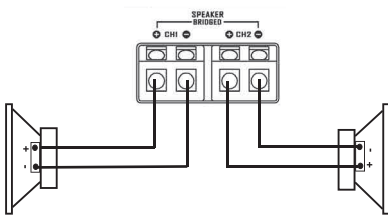

**NOTE!**

Minimum amplifier load is 2 ohm in stereo mode, lower impedances may damage the amplifier. The speakers can be coaxial speakers or 2/3-way kits.

#### Filter settings CH 1/2 for 2-channel stereo use

The high pass filter blocks very low frequencies from reaching the speakers, mostly used to protect small speakers from deep bass.

Set the push button to **ON** and the **HPF / LPF** button to **HPF (button OUT)** to activate the filter, or **OFF** if you want to run the amplifier in full range mode without limiting the frequency range. Adjust with the **HPF control** after your own taste, a normal setting is 50 - 70 Hz.

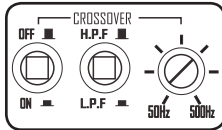

#### One 4 ohm subwoofer bridged

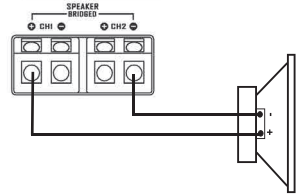

**NOTE!**

Minimum speaker impedance in bridged connection is 4 ohm, this connection gives a 2 ohm load with a 4 ohm subwoofer (the load is halved when connected in bridge mode). Do **NOT** use subwoofers with lower impedance than 4 ohm. Connect speaker + to **CH1+** and speaker - to **CH2 -**.

#### Filter settings CH 1/2 for subwoofer use

The low pass filter is mostly used for subwoofers. It will allow low frequencies only and blocks higher frequencies. A typical setting is 60 - 70 Hz.

Set the push button to **ON** and the **HPF / LPF** button to **LPF (button IN)** to activate the filter, or **OFF** if you want to run the amplifier in full range mode without limiting the frequency range.

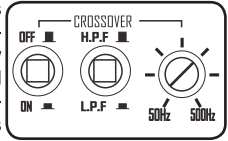

For power wiring, see page 3-4

For high or low level input wiring, see page 4

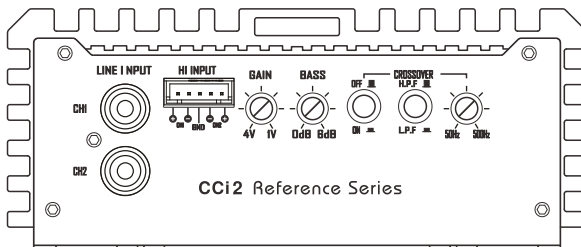

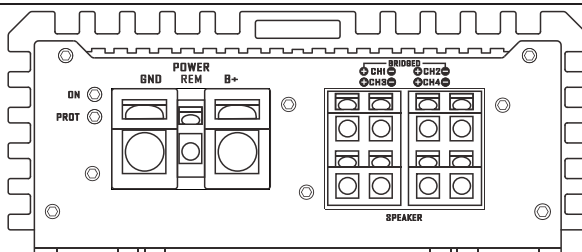

### Speaker wiring CCi4 / CCi44

1. Four fullrange speakers. One pair in front and one pair in rear.

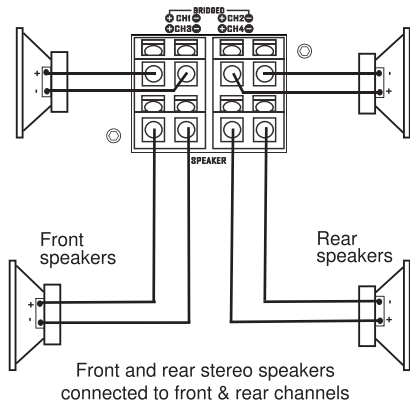

Front and rear stereo speakers connected to front & rear channels

#### Filter settings front channels CH 1 / 2

The high pass filter blocks very low frequencies from reaching the speakers, mostly used to protect small speakers from deep bass.

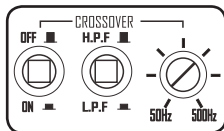

Set the push button to **ON** and the **HPF / LPF** button to **HPF (button OUT)** to activate the filter, or **OFF** if you want to run the amplifier in full range mode without limiting the frequency range. Adjust with the **HPF control** after your own taste, a normal setting is 50-70 Hz.

#### Filter settings rear channels CH 3 / 4

For the rear channels 3/4 the filter should be adjusted in the same way as for channels 1/2.

For power wiring, see page 3-4  
For high or low level input wiring, see page 4

2. Two fullrange speakers and one subwoofer bridged to CCi4 / CCi44 (3-channel mode).

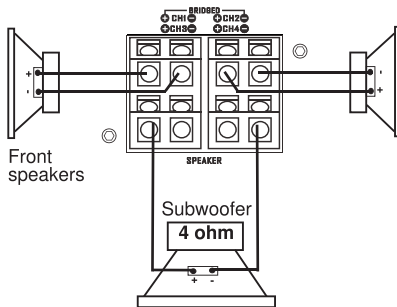

Rear or front stereo speakers connected to channels 1 / 2 and subwoofer to channels 3 / 4.

#### Filter settings front channels CH 1 / 2

The high pass filter blocks very low frequencies from reaching the speakers, mostly used to protect small speakers from deep bass.

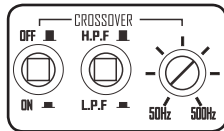

Set the push button to **ON** and the **HPF / LPF** button to **HPF (button OUT)** to activate the filter, or **OFF** if you want to run the amplifier in full range mode without limiting the frequency range. Adjust with the **HPF control** after your own taste, a normal setting is 50-70 Hz.

#### Filter settings rear channels CH 3 / 4

The low pass filter is used for subwoofers. It will allow low frequencies only and blocks higher frequencies. A typical setting is 60 – 70 Hz.

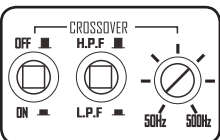

Set the push button to **ON** and the **HPF / LPF** button to **LPF (button IN)** to activate the filter.



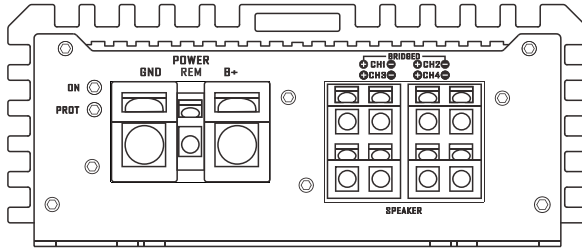

### Speaker wiring CCi4 / CCi44

3. Two subwoofers or stereo speakers bridged to CCi4 / CCi44.

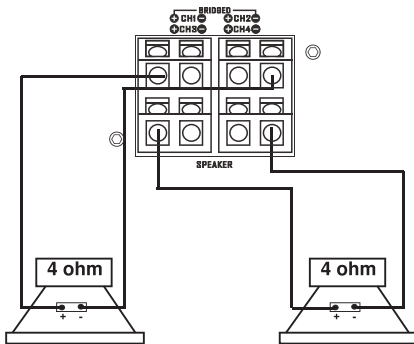

One 4 ohm subwoofer or speaker connected to channels 1 / 2 and one 4 ohm subwoofer or speaker connected to channels 3 / 4.

Filter settings front channels CH 1 / 2

Filter settings rear channels CH 3 / 4

The low pass filter is mostly used for subwoofers. It will allow low frequencies only and blocks higher frequencies. A typical setting is 60 – 70 Hz.

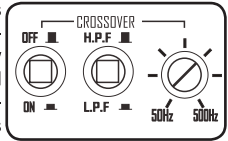

Set the push button to **ON** and the **HPF / LPF** button to **LPF (button IN)** to activate the filter.

When the CC-4 is used for bridging a stereo speaker pair set use only the **HPF** filter. Set the push button to **ON** and the **HPF / LPF** button to **HPF (button OUT)** to activate the filter, or **OFF** if you want to run the amplifier in full range mode without limiting the frequency range.

Adjust with the **HPF control** after your own taste, a normal setting is 50-70 Hz.

For power wiring, see page 3-4

For high or low level input wiring, see page 4

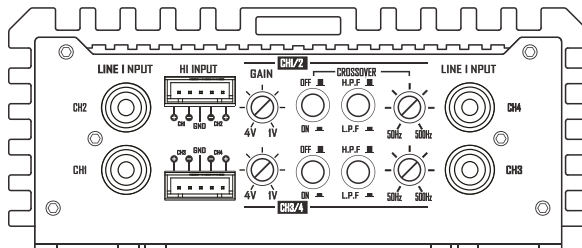



# Troubleshooting Testing

If problems occur during the installation, or later, this guide might help you to find out what's wrong.

## THE AMPLIFIER IS DEAD:

1. Check power lead, ground and remote connections at the amplifier using a multi meter.
2. Check the battery terminal connections.
3. Check the power lead fuse or circuit breaker. If fuse damage continues, inspect the power lead for short circuits.
4. Check the amplifier protection fuses. Are these broken change to new ones with the same value. If short circuiting continues, contact your local DLS dealer. A fault may exist in the amplifier.
5. To start the amplifier requires a remote voltage of 9-15 volt. Check the voltage with a multi meter.

## AMPLIFIER PROTECTION FUSE BLOWS AT LOW VOLUME :

1. One or more speaker cables are shorted. Make an insulation test with a multi meter. The cables must not have a connection to earth.

## THE AMPLIFIER TURNS OFF AFTER 10 - 30 MINUTES.

The amplifier is overheating due to inadequate ventilation. Check mounting position is free from obstruction.

### Do this:

1. Move the amplifier to a place with better ventilation.
2. Install one or two fans to cool down the heat-sink.
3. Overheating can also be caused by an impedance load below the level permitted.

## NO OUTPUT FROM ONE OR MORE SPEAKERS:

### Check the following:

1. Balance control position.
2. Fader control position.
3. Speaker cable connections to both amplifier and drivers.
4. Signal lead plugs and cables.
5. Change left and right signal lead plugs in the amplifier to see if the problem moves to a different speaker, the lead has a fault.  
If the problem remains, the speaker or amplifier are at fault.

Before you finish the installation, you should do the following tests to make sure the wiring is correct and everything is operating properly.

## Reconnect Battery

When wiring is complete, reconnect the battery negative terminal.

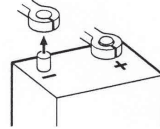

## Test power wiring

1. Turn on the head unit but do not turn up the volume. The amplifier power light should come on. If not, check the remote and +12 volt wires. Also check the ground connection.
2. Turn up the head units volume slightly. All speakers should operate. If not, check wiring connections at amplifier and speakers.

## Test speaker connections

Make sure the speakers are connected right. Use the balance control on the head unit to make sure right channel is on right speaker etc. If speakers don't play at all, one or both speaker wires may be disconnected.



### Professional Tip:

#### NOISE PROBLEMS

WHINING NOISE VARYING WITH ENGINE REVOLUTIONS:

##### Do this:

1. Rewire the power supply (12 V) to source unit direct from battery.
2. Rewire ground wire from source unit to clean position on chassis.
3. Check all power connections to ensure that they are clean and tight.
4. Check quality of system ground connection.
5. Install a Power Cap capacitor. This can be helpful against most noise problems.

#### CONSTANT WHINING NOISE:

##### Do this:

1. Ensure that all equipment has a common ground point.
2. Check quality of earth strap connection from battery negative terminal to chassis.
3. Disconnect signal cables from amplifier to see if noise disappears. If so the leads are picking up noise. Test this by laying a new cable over the seats and reconnecting to the amplifier. If the noise does not return, re-route original cable away from source of interference.

If noise remains regardless of cable position, try to use so called Quasi-balanced signal cables. DLS PRO-cables are Quasibalanced.

### Professional Tip:

#### Installing in trunk

When installing the amplifier in the trunk, run the power wires along the same path as the other vehicle wiring. Many cars have insulated channels for wiring, you will have to remove the door sill trim and the carpet.

### Professional Tip:

#### Crimp connections

Purchase crimp connectors and crimping tool. Connectors are color coded.

1. Strip 1/4 inch (6 mm) of insulation from the wire.
2. Insert into connector
3. Crimp tightly

### Professional Tip:

#### SPEAKER POLARITY CHECK.

All speakers in a car audio system should be connected in phase (the same polarity). All speaker cones must move in the same direction. Out of phase speakers will cause a lack of bass, and a poor stereo soundstage.

##### Checking polarity:

Hold the - connection of the speaker wire to the - terminal of a 1,5 Volt flashlight battery. Tap the + wire on to the + terminal of the battery, and observe the movement of the cone. The cone should move outwards when the wire touches the battery, and inwards when the battery is removed. If it is the other way around, the speaker has been connected backwards and it must be removed and connected correctly.

If your system also has a subwoofer connected through a passive 6 or 12 dB crossover, try to connect this with various polarity and judge what sounds best. The phase shift in passive crossovers sometimes makes it necessary to change polarity.

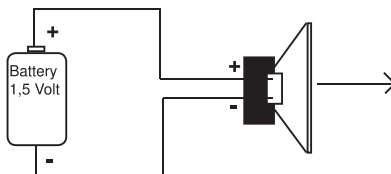

**NOTE!** Tweeters can not be tested this way, double check the connections instead.

### Professional Tip:

#### Securing wires

Use wire ties to bundle together when possible. (But never bundle speaker wires or signal cables together with power wires.)

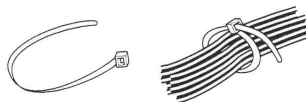

### Professional Tip:

#### Speaker and power wires

Do not run speaker and power wires next to each other. Power wires can generate a "siren" sound in the speakers. Run speaker and power wires on opposite sides of the car.



# Specifications

All output power ratings are RMS Watts @ 14,4 VDC, CEA standard

	<b>CCi500</b>	<b>CCi1000</b>
Number of channels	1	1
Amplifier class	D	D
Power output RMS, 1 ohm	500 W	1000 W
Power output RMS, 2 ohm	400 W	700 W
Power output RMS, 4 ohm	250 W	450 W
Signal to noise ratio, A-weighted	92 dB	97 dB
Damping factor	140	154
Frequency response	10 Hz - 250 Hz	10 Hz - 250 Hz
Input impedance, low level	22 kohm	22 kohm
Input sensitivity	1 - 4V	1 - 4 V
Input impedance, high level	45 ohm	45 ohm
High level input with auto start	Yes	Yes
Filter low pass variable	35 - 250Hz /12 & 24 dB slope	35 - 250Hz /12 & 24 dB slope
Bass boost @ 60 Hz	0 - +6 dB	0 - +6 dB
Subsonic filter	30 Hz ON / OFF	30 Hz ON/OFF
Phase switch	0 / 180°	0 / 180°
Remote sub level control	Yes, with 5 meters cable	Yes, with 5 meters cable
Power consumption, idle	0,8 A	1,2 A
Power consumption, max	80A	102 A
Fuse (no internal fused used)	Use external fuse 60 A	Use external fuse 100 A
Dimensions HxWxD(mm / inch)	54 x 129 x 320 / 2,1 x 5,1 x 12,6	54 x 129 x 370 / 2,1 x 5,1 x 14,6
Power terminal size	2 AWG / 33 mm <sup>2</sup>	2 AWG / 33 mm <sup>2</sup>
Speaker terminal size	7 AWG / 10 mm <sup>2</sup>	7 AWG / 10 mm <sup>2</sup>
Weight	2,4 kg	2,9 kg

	<b>CCi2</b>	<b>CCi4</b>	<b>CCi44</b>
Number of channels	2	4	4
Amplifier class	AB	AB	AB
Power output RMS in 4 ohm	2 x 110 W	4 x 50 W	4 x 85 W
Power output RMS in 2 ohm	2 x 170 W	4 x 70 W	4 x 110 W
Power output RMS 4 ohm bridged	1 x 340 W	2 x 140 W	2 x 220 W
Signal to noise ratio, A-weighted	110 dB	110 dB	110 dB
Damping factor	>150	>250	>300
THD @ 5 W, 1 kHz	< 0,02%	< 0,02%	<0,02%
Frequency response	10 Hz - 50 kHz	10 Hz - 55 kHz	10 Hz - 60 kHz
Input impedance, low level	6 kohm	6 kohm	5 kohm
Input sensitivity	1 - 4V	1 - 4V	1 - 4 V
Input impedance, high level	45 ohm	45 ohm	45 ohm
High level input	Yes	Yes	Yes
Filter high-pass adjustable	50 - 500 Hz*	50 - 500 Hz*	50 - 500 Hz*
Filter low pass adjustable	50 - 500 Hz*	50 - 500 Hz *	50 - 500 Hz*
* can be switched in/out			
Bass EQ @ 60 Hz	0 - +6 dB	-	-
Power consumption, idle	0,5 A	0,5 A	0,7 A
Power consumption, max	43A	40A	64 A
Fuse (no internal fuses used)	use external fuse 40 A	use external fuse 40 A	use external fuse 60 A
Extra	Internal cooling fan	Internal cooling fan	Internal cooling fan
Dimensions HxWxD(mm)	54 x 129 x 260	54 x 129 x 260	54 x 129 x 320
Dimensions (inch)	2,1 x 5,1 x 10,2	2,1 x 5,1 x 10,2	2,1 x 5,1 x 12,6
Weight	1,87 kg	1,8 kg	2,4 kg

We follow a policy of continuous advancement in development. For this reason all or part of specifications & designs may be changed without prior notice.