

WELCOME!

Thank you for purchasing our KLH Faraday In-wall speakers. We have constructed these speakers with the finest quality materials to provide many years of outstanding performance.

FOR YOUR SAFETY

Important Safety Instructions!

1. READ these instructions.
2. KEEP these instructions.
3. HEED all warnings.
4. FOLLOW all instructions.
5. DO NOT use this apparatus near water.
6. CLEAN ONLY with dry cloth.
7. DO NOT block any ventilation openings. Install in accordance with the manufacturer's instructions.
8. Do not install near any heat sources such as radiators, heat registers, stoves, or other heat producing appliances
9. ONLY USE attachments/accessories specified by the manufacturer.
10. DO NOT expose to excess moisture or liquids, and do not place containers with liquids on top of speakers.



The exclamation point, within an equilateral triangle, is intended to alert the user to the presence of important operating and maintenance (servicing) instructions in the literature accompanying the product.



The lightning flash with arrowhead symbol within an equilateral triangle, is intended to alert the user to the presence of uninsulated "dangerous voltage" within the product's enclosure that may be of sufficient magnitude to constitute a risk of electrical shock to persons.



WARNING: Do Not Open! Risk of Electrical Shock. Voltages in this equipment are hazardous to life. No user-serviceable parts inside. Refer all servicing to qualified service personnel.



EU COMPLIANCE INFORMATION:

Eligible to bear the CE mark, Conforms to European Union EMC Directive 2004/108/EC; European Union Restriction of Hazardous Substances Recast (RoHS2) Directive 2011/65/EC; European Union WEEE Directive 2002/96/EC.

WEEE NOTICE

Note: This mark applies only to countries within the European Union (EU) and Norway.

This appliance is labeled in accordance with European Directive 2002/96/EC concerning waste electrical and electronic equipment (WEEE). This label indicates that this product should not be disposed of with household waste. It should be deposited at an appropriate facility to enable recovery and recycling.

SPEAKER PLACEMENT AND LOCATION

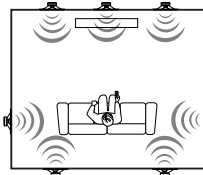

Optimum speaker placement depends on personal listening preference and, when used in home theater applications, follow standard listening recommendations for left, center, right and surround usage.

INSTALLATION

If you are installing in new construction, it is recommended that you use an install kit. These kits are put in place before the installation of drywall. The install kit adds security, and can be used to more accurately cut the hole for final installation (See illustrations 1-7).

Note: Recommended install kit is WK-6600.

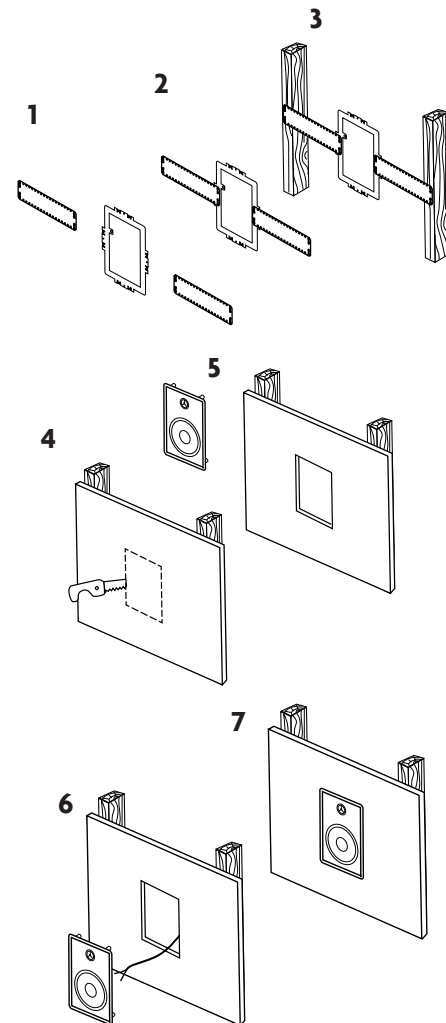

For existing walls, make sure the speaker cutout is placed between two joists with plenty of clearance. Use a stud finder to locate joists, and mark locations. Be sure to avoid electrical wires and plumbing when cutting hole for installation. If you encounter electrical wiring or plumbing, you may have to consider another location (See illustration below).

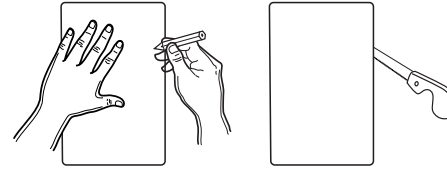

Connect the wires using the provided fasteners by pushing down on the spring clip and inserting the trimmed, exposed wire into the clip hole. Remove pressure on the clip, and the wire should be locked into place. Remember, red clip is + and black clip is - (See illustration at below).

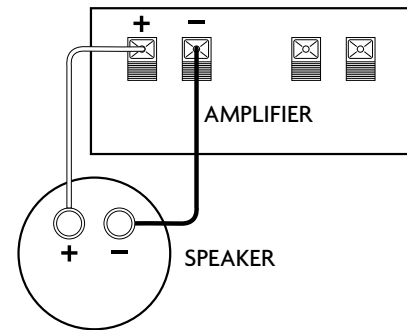

Make sure that grille is removed from the speaker. Place the speaker into the hole and press tightly against drywall with one hand, and tighten each of the screws until the speaker is firmly in place. (See illustrations 1-3).

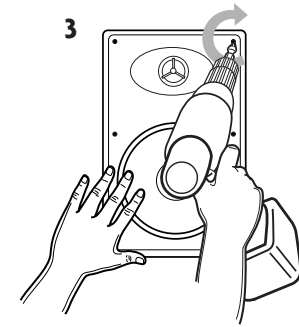
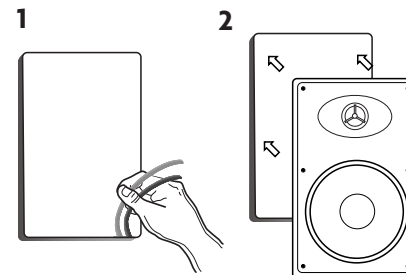

Before placing grille on speaker, make sure there are no vibrations when playing. If so, check the installation screws to see if they need further tightening

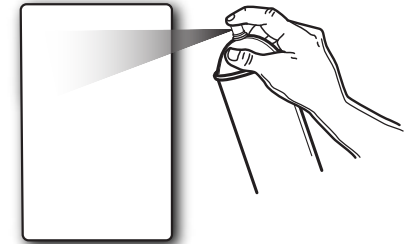

PAINTING THE SPEAKER GRILLE

This speaker grille may be painted. To apply spray paint to the grille, follow the manufacturer's instructions and remember to remove the scrim before finishing. To paint the outer bezel on press fit speaker chassis, use the cutout template as mask, and paint (See illustration above).

MAINTENANCE

These speakers require little maintenance and, if cleaning is needed, you may use a dry cloth. If the speaker is subject to smoke or grease, a mild detergent and moistened cloth may be used. DO NOT use harsh chemicals or abrasives.

LIMITED LIFETIME WARRANTY

This warranty is non-transferable, and only applies to the individual that made the original purchase.

For warranty/service issues, please contact your place of purchase.

Please hold on to your original receipt.

The warranty covers any production and material defects of purchased product.

The following is NOT COVERED by the warranty:

1. Accidents, misuse, poor maintenance, electrical overloads such as lightning or voltage.
2. No DIY, must be installed by CEDIA-qualified installer. No abuse.
3. Incorrect installation of product.
4. Altered serial number.
5. Transportation costs for service call.

Replacement item cannot exceed the cost of the item under warranty. The supplier is responsible for only repair or replacement.

KLH[®]
LOVE YOUR MUSIC™

FARADAY

IN-WALL MANUAL

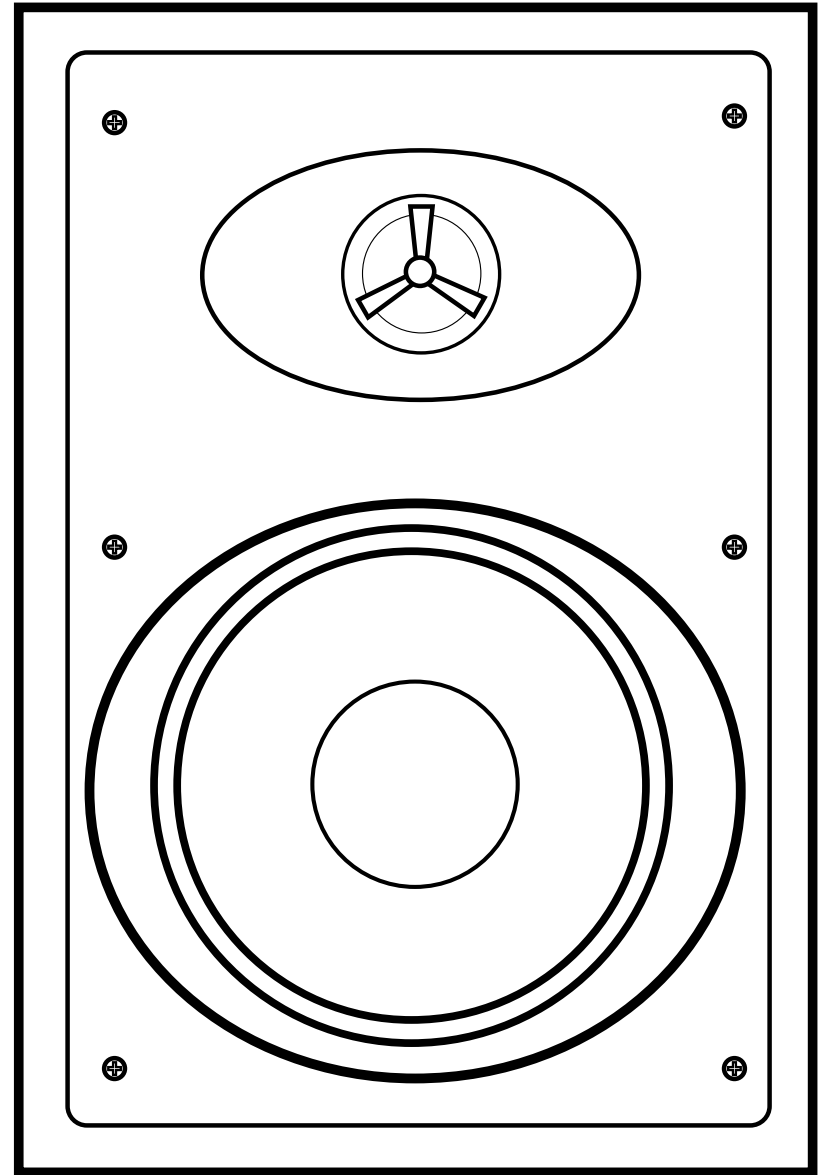

KLH[®]
LOVE YOUR MUSIC™