



PTA-100TV

7-inch WiFi Multimedia Navi 2DIN



User Manual

Table of Contents

I.	Introduction	4
II.	Quick Start Guide	5
	II.1 Turning the Power On	5
	II.2 User Interface	6
	II.3 Common Screen Operation	7
III.	Bluetooth	8
	III.1 Connect to Bluetooth	8
	III.2 Bluetooth Dialing	9
IV.	Internet Access	10
V.	Mirroring	11
	V.1 Android	11
	V.2 Apple iOS	11
VI.	Radio	13
VII.	Music	14
VIII.	Video	16
IX.	Digital Television	17
X.	Steering Wheel Control	19
XI.	Reference	20
	XI.1 Maintenance	20
	XI.2 Troubleshooting	20
XII.	Installation/ Wire Connection Guide	21
	XII.1 Precautions on installation and connection	21
	XII.2 Wiring Information	22
	XII.3 Installation procedure	23
XIII.	GPS Antenna	23
XIV.	Customer Service	25

PRECAUTIONS

IMPORTANT



To ensure proper use, please read through this manual before using this product. It is especially important that you read and observe WARNINGS and CAUTIONS in this manual. Please keep the manual in a safe and accessible place for future reference.

WARNINGS: (To prevent accidents and damage)

DO NOT install any unit or wire any cable in a location where:

- It may obstruct the steering wheel and gearshift lever operations.
- It may obstruct the operation of safety devices such as air bags.
- It may obstruct visibility.

DO NOT operate the unit while driving.

- If you need to operate the unit while driving, be sure to look around carefully.
- The driver must not watch the monitor while driving.

CAUTION



For safety

- Do not raise the volume level too much, as this will make driving dangerous by blocking outside sounds, and may cause hearing loss.
- Stop the car before performing any complicated operations.

For a longer service life, be sure to read the following cautions:

- If you have parked the car for a longtime in hot or cold weather, wait until the temperature in the car becomes normal before operating the unit.
- Do not disassemble or modify the set in any way. Doing so may result in damage.
- If a problem should occur, have the set inspected at your store of purchase
- Small black and shiny spots inside the liquid crystal panel are normal for LCD products.

I. Introduction



ASUKA PTA-100 is a revolutionary In-car entertainment product designed to satisfy all users' desire to access the internet while in car. On-line entertainment is beyond traditional broadcasting services & pre-recorded media contents; it brings you more entertaining and smarter user experience than ever before.

PTA-100TV Product Overview

- 7" In Dash WiFi Multimedia Navi 2 DIN Head-unit
- ASUKA-style User-Defined User Interface
- Multi-touch Control (for volume adjustment and display off)
- On-line Entertainment & Pre-recorded Media Contents
- Smartphone Mirroring via Cable HDMI in and Wireless Miracast
- Built-in Bluetooth technology for hands-free talking and audio streaming

II. Quick Start Guide

II.1 Turning the Power On

1. Turn on the ACC or IGN of the vehicles.

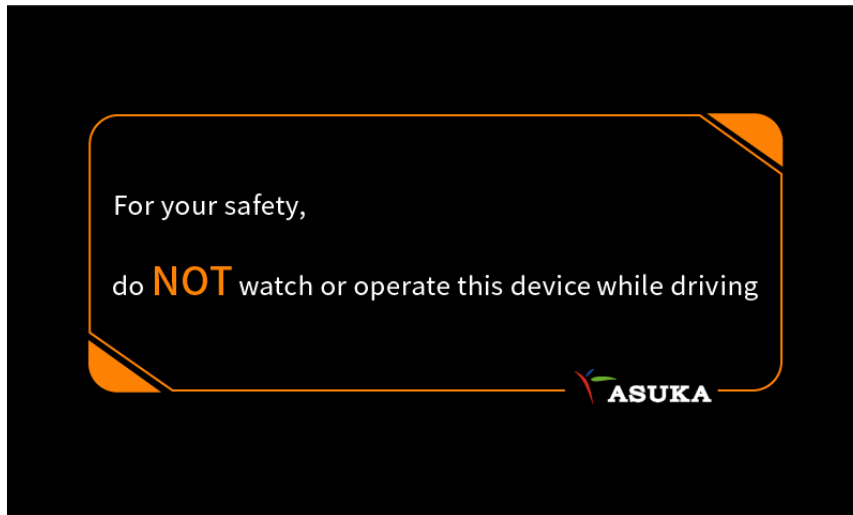

2. When the head unit is activated, you will see a reminder after startup screen

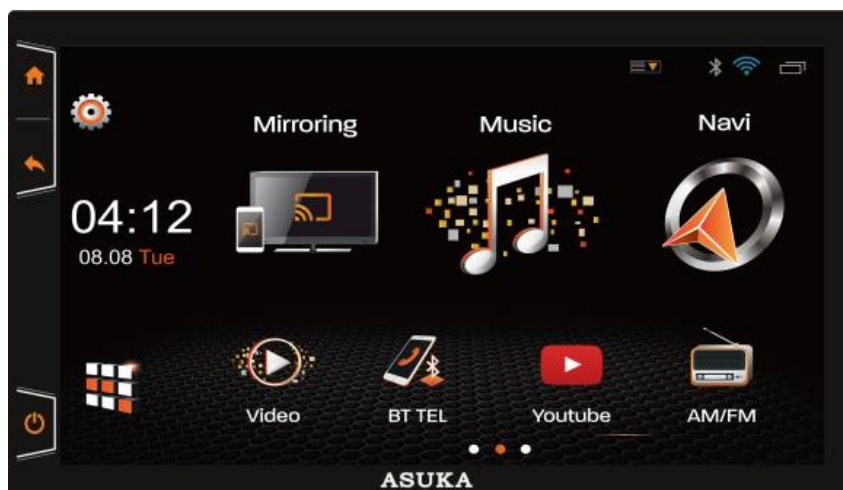

3. Now you can touch any icon on the screen to activate the corresponding function.

II.2 User Interface

User Interface Introduction

- On the left side of the screen, there are three touch keys.



- Home Screen



II.3 Common Screen Operation

Touch

- Touch the screen gently to select the item on the screen.

Touch and Hold

- Touch the screen and keep your finger in place until display changes allow you to drag the icon to the position you want it to be.

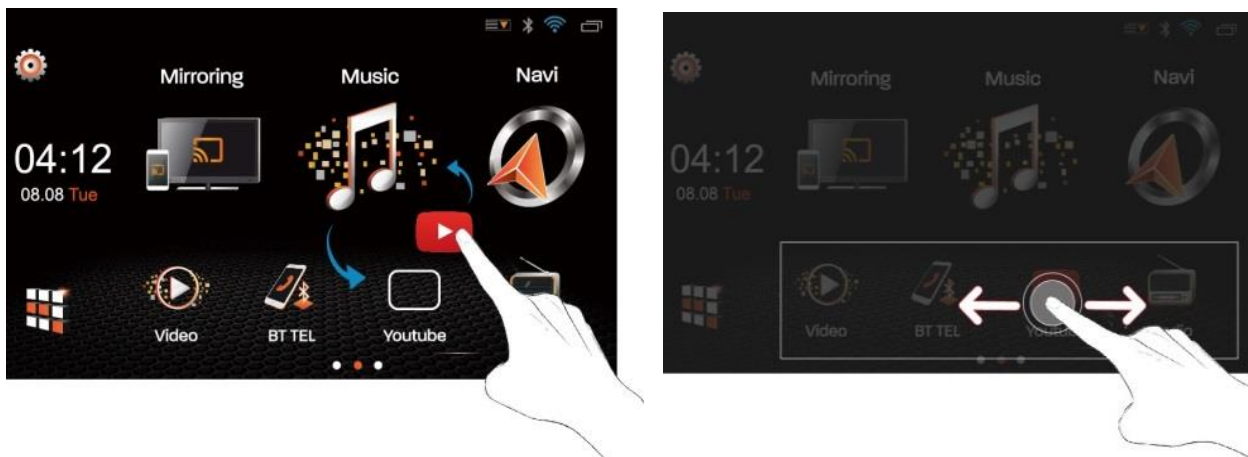

Swipe

- Swipe your finger left or right on the screen to change the page.
- Swipe your finger up or down on the screen to scroll the screen.

Multi-touch

- Swipe left or right with two fingers to adjust the volume.
- Pinch three or five fingers together to turn off the display.



III. Bluetooth

III.1 Connect to Bluetooth

1. Turn on the Bluetooth function of your mobile devices.

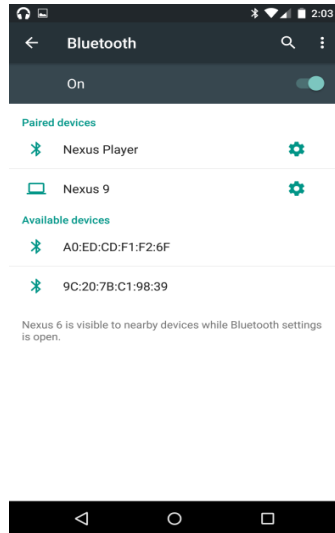

Example of Android Devices



iOS Devices

2. Select “Bluetooth” under Settings.” Select the device you want to pair.



3. When the mobile device is paired with PTA-100TV successfully, the indicator on the screen will turn to orange.



III.2 Bluetooth Dialing

Dial out using keypads and contact list.

Option 1

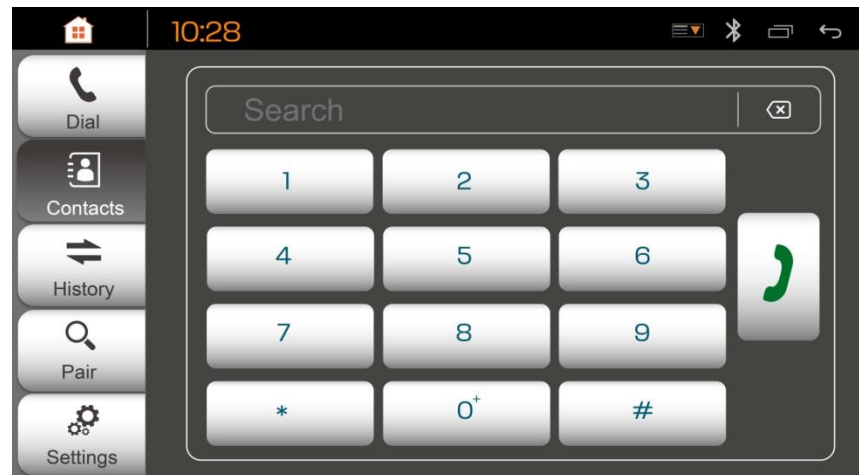

Keypads

Option 2

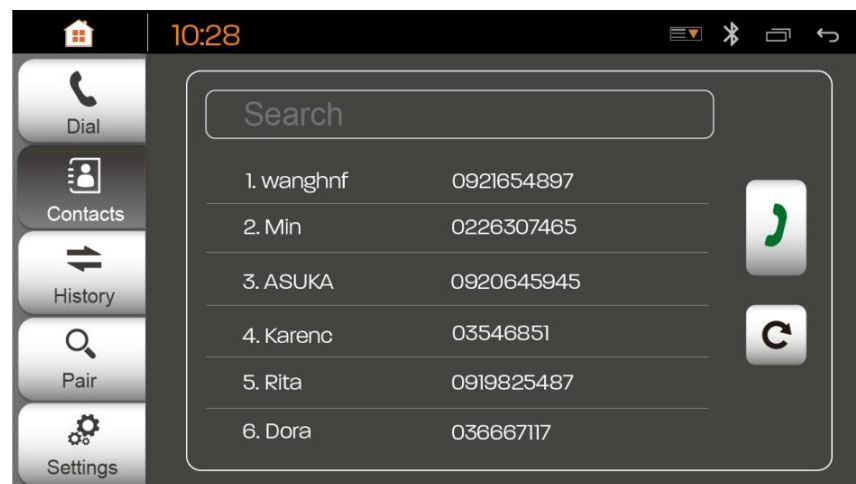

Contact List

IV. Internet Access

1. Turn on the hotspot of your mobile device.

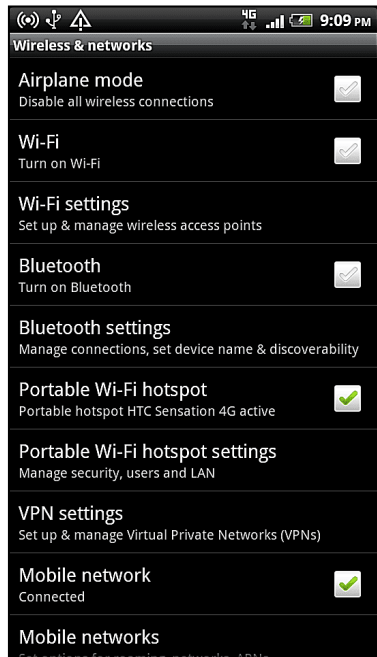

Example of Android Devices

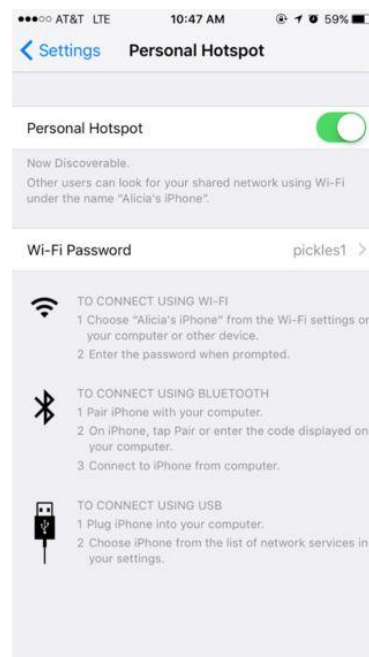

iOS Devices

2. Select "WiFi" under "Settings" of PTA-100TV home menu
3. Select the name of hotspot shared by the mobile phone and key in the requested password.
4. Wi-Fi connected.

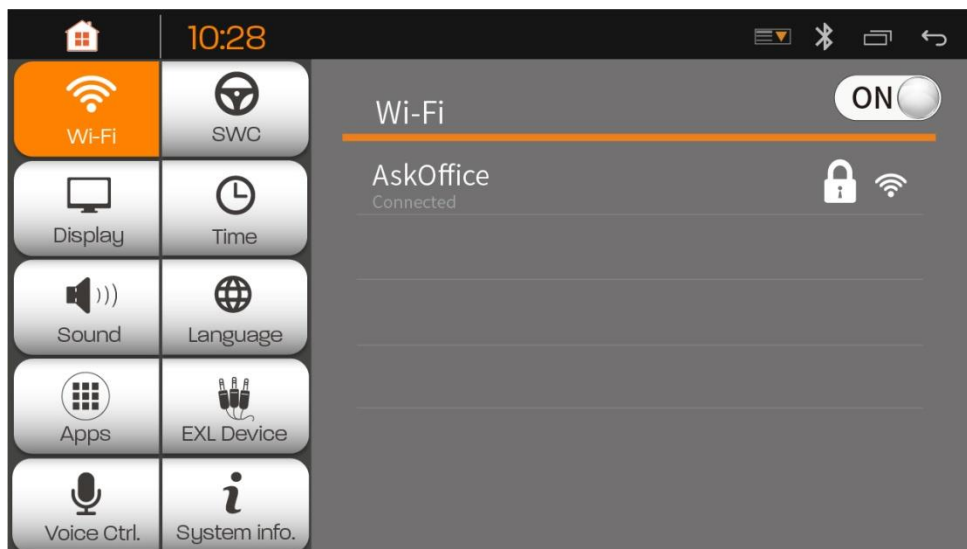

V. Mirroring

This function allows users to cast the mobile device to the screen of the head unit. PTA-100TV supports two ways of Mirroring: via Miracast for Android and via HDMI for iPhone.



V.1 Android

Step 1: Make sure your mobile device is Miracast-compatible.

Step 2: Select “Miracast” under “Mirroring”.

Connecting your Android device

Step 1: Select Application

Step 2: Select Setting

Step 3: Under Connect and Share tap Screen Mirroring

Step 4: Select PTA-100TV

Step 5: Once connected, your mobile device’s screen will now be displayed on PTA-100T

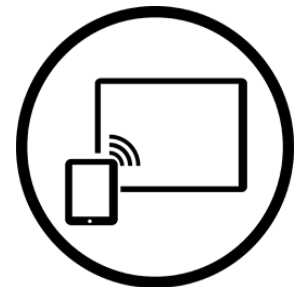

V.2 Apple iOS

Connecting your iOS device

Step 1: Select mirroring application on PTA-100TV. Select HDMI.

Step 2: Be sure the iOS device is powered on.

Step 3: Connect the Apple Lightning Digital AV Adapter /Apple 30-pin Digital AV Adapter, to iOS devices.

Step 4: Connect the HDMI cable to the Apple Lightning AV adapter / Apple 30-pin Digital AV





Adapter

Step 5: You should be able to see your iOS image on PTA-100TV.

VI. Radio



1. Scan Button
2. Add to Favorite
3. Equalizer Settings
4. Mute
5. Drag to change frequency
6. AM/FM band Switch.
7. Manual tune backward
8. Display current frequency
9. Manual tune forward
10. Searches for stations
11. Preset list button
12. Favorite list button

VII. Music

There are two options to choose to play music
[USB] and [Bluetooth]

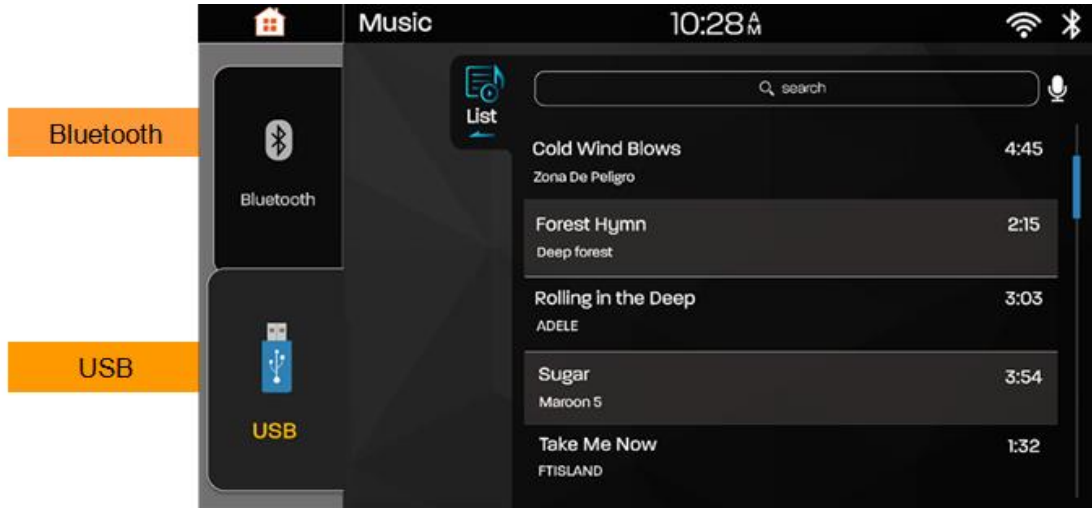

Basic Music Interface



Listen to Music by Bluetooth

Before selecting Bluetooth, pair PTA-100TV to your mobile device. [See Page8]



VIII. Video

Video Interface

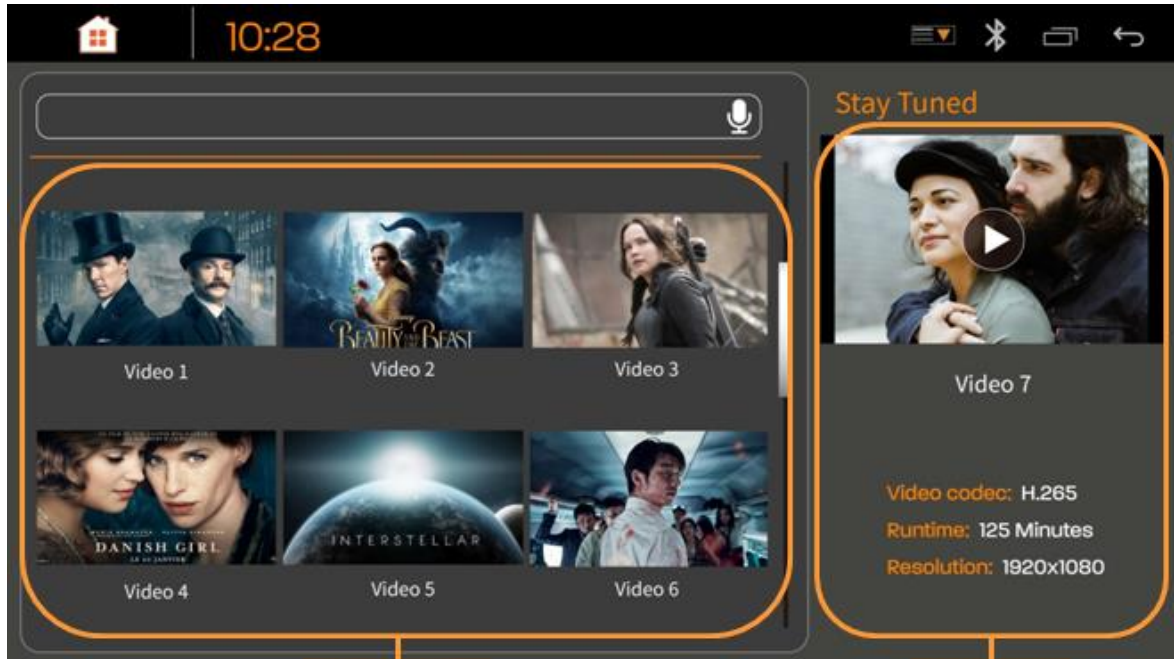

Video List

Preview

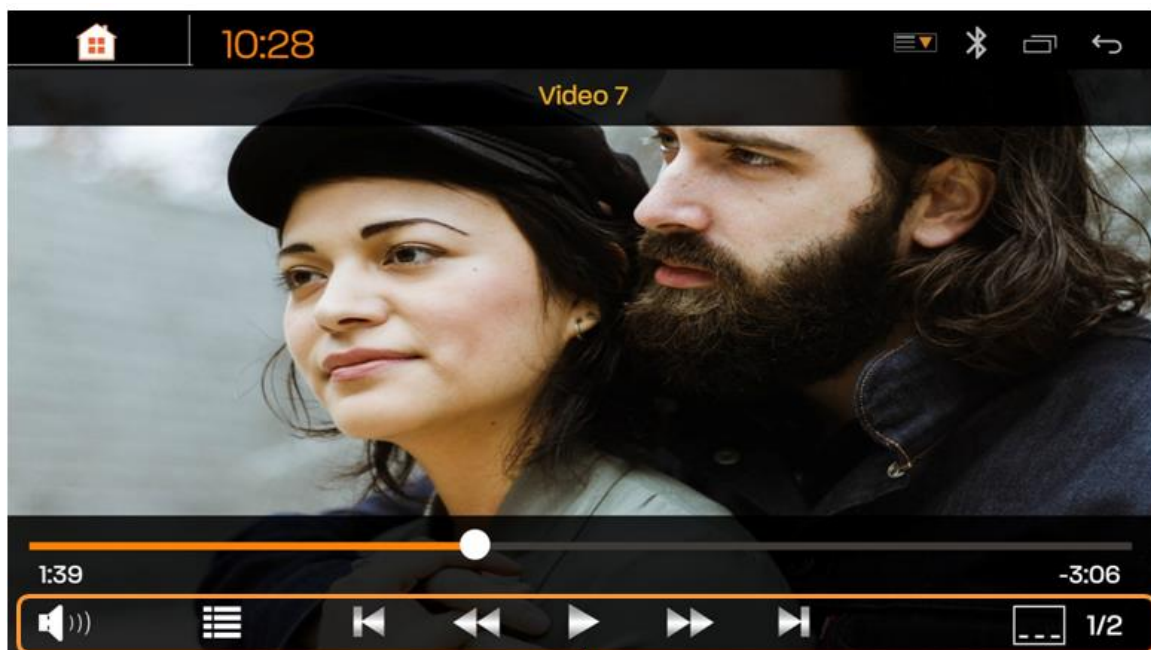

Control Buttons

IX. Digital Television

Digital Television is an optional for countries except United States of America.

Select TV icon to watch DTV

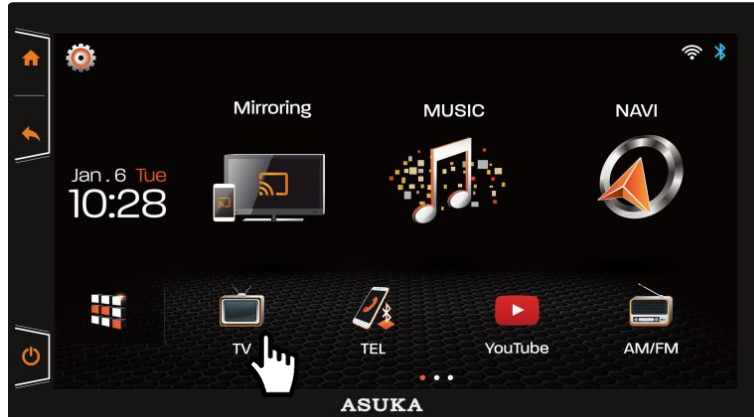

DTV Interface

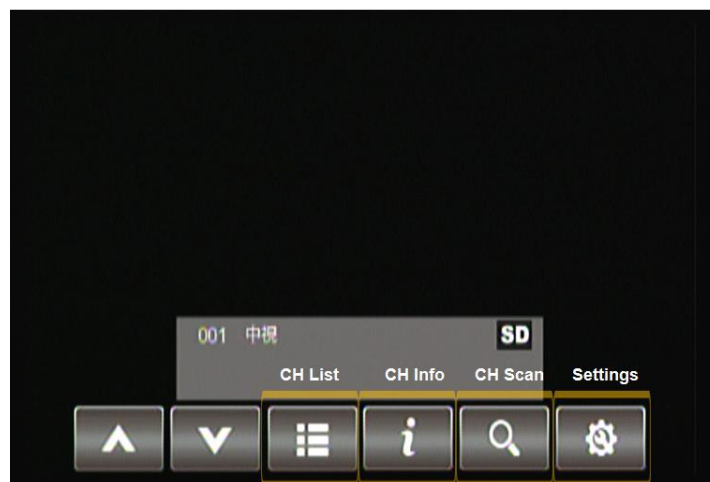

To change language by select [Setting]



Select [CH Scan] to search for the available channels automatically

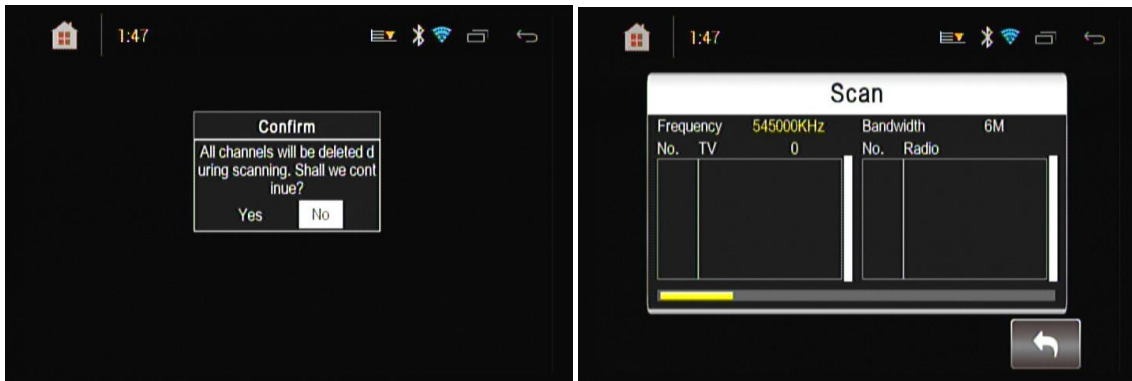

Use [CH▲] / [CH▼] or Select CH List to change channels

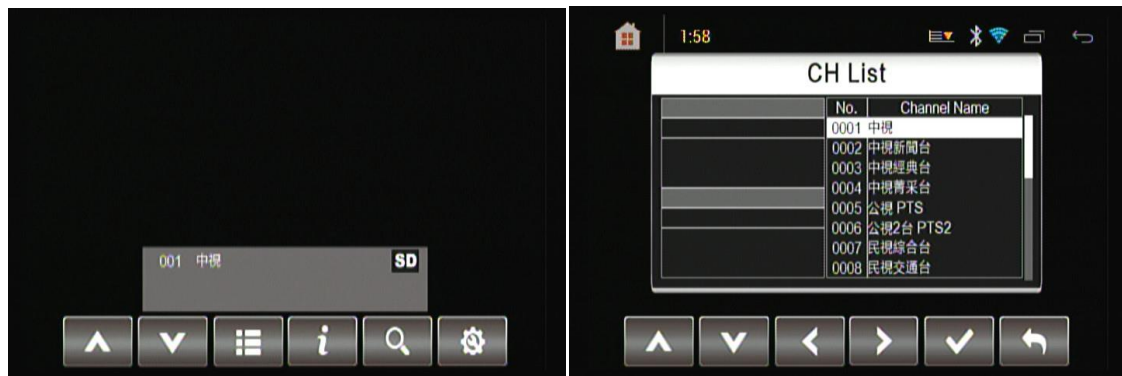

X. Steering Wheel Control

Steering wheel controls allow drivers to keep their eyes on the road.



Step 1: Select [SETUP ICON] then [SWC]



Step 2: Select VOL+ on PTA-100TV

Step 3: Press and hold the function button on the steering wheel, wait until the display shows paired.

Step 4: Repeat this process until all relevant functions are programmed.

Step 5: Once all functions have been set, exit the SWC interface and back to Home screen

Step 6: Double check if programming was successful by pressing the VOL+ and VOL – on the steering wheel.

XI. Reference

XI.1 Maintenance

- Do not use any solvent (for example, thinner, benzene, etc.), detergent, or insecticide. This may damage the monitor or the unit.
- Cleaning the Liquid Crystal Display Screen

The liquid crystal display screen tends to collect dust, so wipe it off occasionally with a soft cloth. The surface is easily scratched, so do not rub it with hard objects.

XI.2 Troubleshooting

What appears to be trouble is not always serious.

Check the following points before calling dealers/ASUKA.



■ General

No sound comes out of the speakers.

- Adjust the volume to the optimum level.
- Check the cords and connections.

No picture is displayed on the screen.

- Turn on the screen.

Playback does not start.

- The format of files is not supported by the unit.

No picture appears on the external monitor.

- Connect the video cord correctly.
- Select the correct input on the external monitor.

■ USB

“Reading” does not disappear from the screen.

- Turn the power off and on again.

While playing a track, sound is sometimes interrupted.

- The tracks are not properly copied into the USB device. Copy the tracks again, and try to play again.



XII. Installation / Wire Connection Guide

XII.1 Precautions on installation and connection

- Mounting and wiring this product requires skills and experience. For best safety, leave the mounting and wiring work to professionals.
- Make sure to ground the unit to a negative 12 V DC power supply.
- Do not install the unit in a location exposed to direct sunlight or excessive heat or humidity. Also avoid places with too much dust or the possibility of water splashing.
- Do not use your own screws. Use only the screws provided. If you use the wrong screws, you could damage the unit.
- After the unit is installed, check whether the brake lamps, blinkers, wipers, etc. on the car are working properly.
- Do not press hard on the panel surface when installing the unit in the vehicle. Otherwise scratches, damage, or failure may result.



XII.2 Wiring Information

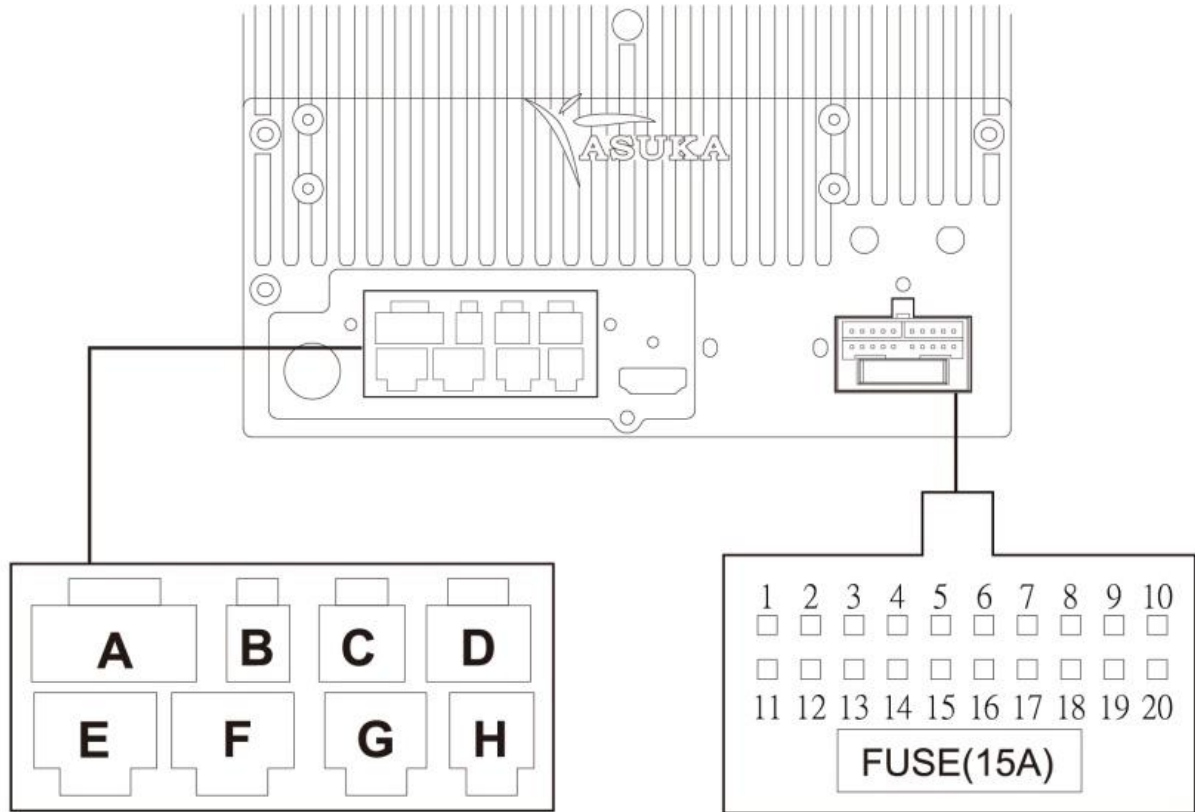

Pin	Color	Function	Pin	Color	Function
1	White	FL+	11	Green	RL+
2	White/Black	FL-	12	Green/Black	RL-
3	Grey	FR+	13	Purple	RR+
4	Grey/Black	FR-	14	Purple/Black	RR-
5	Pink	BRAKE	15	Yellow	BAT+
6	Orange	ILL	16	Black(Thick)	GND
7	Red/Black	RXD	17	Red	ACC
8	Blue/White	SWC 1	18	Blue	ANT+12V
9	Brown	REVERSE	19	Blue/Black	SWC 2
10	Black	SWC GND	20	Red/White	TXD

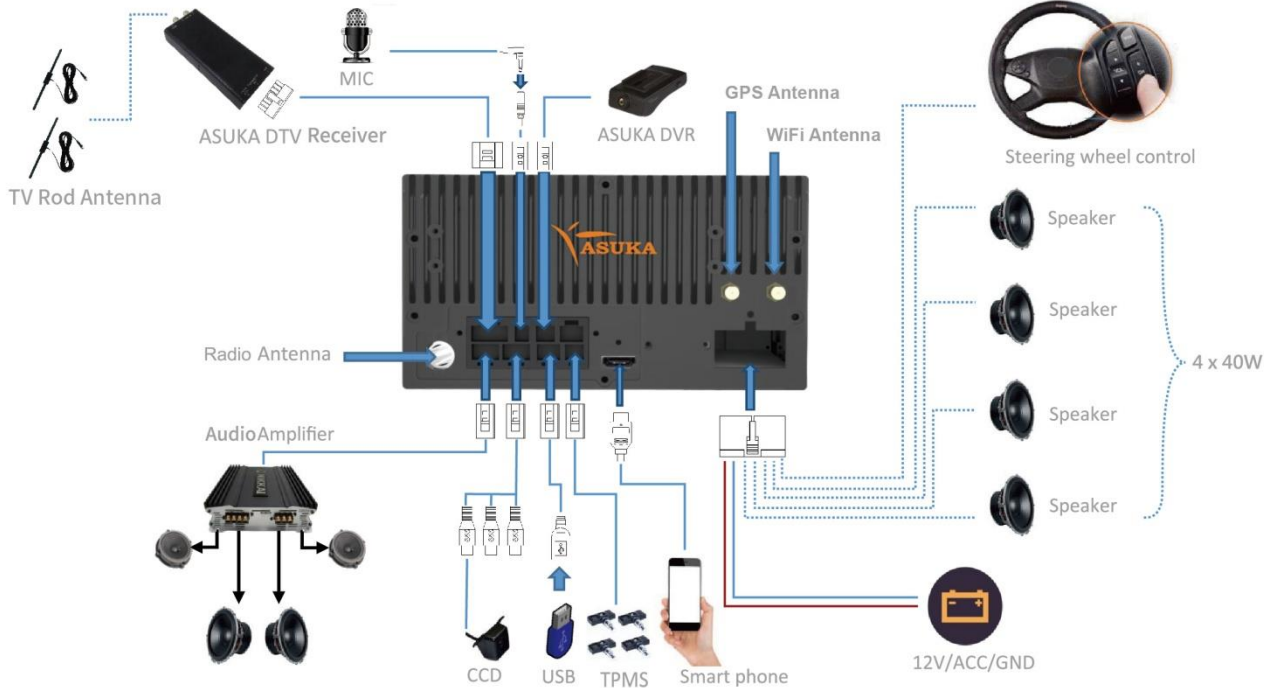

XII.3 Installation procedure

1. To prevent a short circuit, remove the key from the ignition and disconnect the Negative (-) battery.
2. Make the proper input and output wire connections for each unit.
3. Connect the speaker wires of the wiring harness.
4. Connect the wiring harness wires in the following order: ground, battery, and ignition.
5. Connect the wiring harness connector to the unit.
6. Install the unit in your car.
7. Reconnect the Negative (-) battery

XIII. GPS Antenna

GPS Antenna

Note:

- The supplied GPS antenna is for installing inside the vehicle. Do not install it outside the vehicle.

- To improve the GPS signal reception, install the GPS antenna horizontally on a flat plane.
- Do not wax or paint the cover of the GPS antenna. This may reduce the performance of the GPS antenna.
- Wipe off the dirt of the mounting surface before installing the GPS antenna.

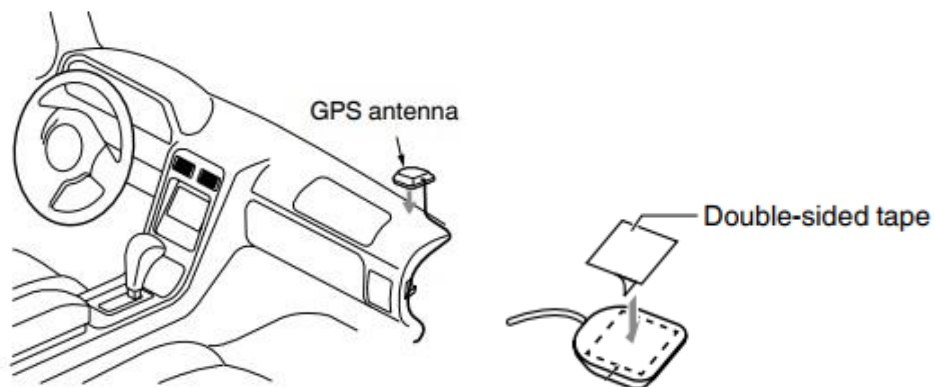



XIV. Customer Service

ASUKA Autotronics Inc.

- Email: sales@asuka-autotronics.com
- Tel: +886 3-666-7117
- <http://www.asuka-autotronics.com>

Thanks for your support; we hope you enjoy our product.