

# PST-10

EXTERNAL POWER SUPPLY FOR TURNTABLE



# INDEX

PACKAGE CONTENT.....	P. 3
DESCRIPTION.....	P. 4
TECHNICAL SPECIFICATIONS.....	P. 5
FRONT AND REAR PANEL.....	P. 6
SET-UP PST-10.....	P. 7
QUICK START.....	P. 8
CONNECTING PST-10.....	P. 9
WARRANTY.....	P. 10
TROUBLESHOOTING.....	P. 11
IMPORTANT SAFETY INFORMATION.....	P. 12

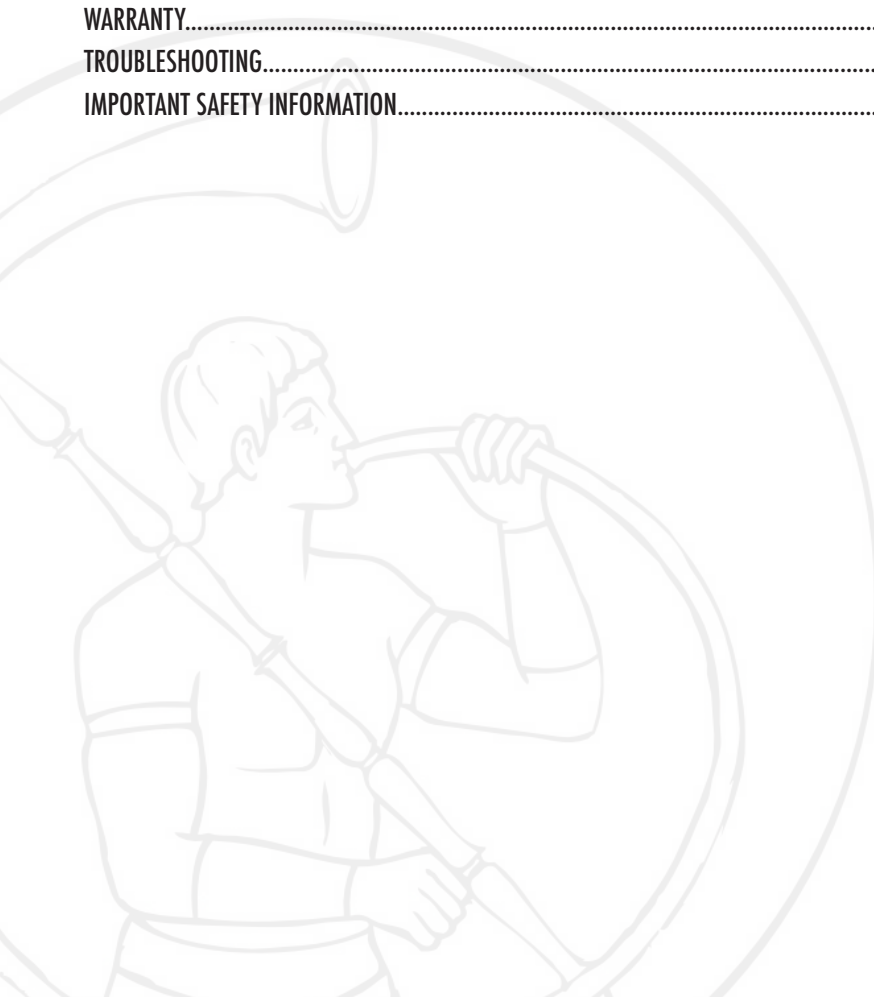

## PACKAGE CONTENT

- 1 PST-10
- 1 AC cable
- 1 PST cable plug for Gold Note turntables
- 1 tool for voltage selection
- User Manual

## DESCRIPTION

The PST-10 is a super inductive power supply designed for all Gold Note low voltage powered turntables.

PST-10 has been engineered with the best quality audio-grade components to enhance the performance of Gold Note Turntables and improve your audio system getting the very best music experience out of your LP's.

PST-10 features a dual choke design powered by a double inductor driving the negative and positive high current stages and featuring an inductive filter on the analogue stage.

The power supply performs 4 transformers 3 of which are strictly dedicated to power supply while 1 transformer exclusively powers the inductive filter and the two chokes.

The Gold Note proprietary Dual Chokes Design perfectly filters the signal voltages in order to eliminate all the possible electrical interferences coming from the AC power system.

The PST-10 uses its massive power supply to shield the turntables from electro-magnetic interferences thus insulating it effectively from the AC power system.

The large, ultra-clean power enhances super low noise, greater dynamic, better resolution and finer details for a more realistic high-end audio performance and pure audio pleasure.

**Every Gold Note product is 100% proudly designed, manufactured and assembled in Italy!**

# TECHNICAL SPECIFICATIONS

Four audio grade Transformers

Four ultra low noise voltage regulator

Inductive interference suppression filter

Maximum variation of output voltage 0,05%

Line noise rejection >80dB

Common mode noise rejection >80dB

Full power response time <2,5µsec

## **POWER**

Power supply 100-120V / 220-240V with auto sense, 50/60Hz

Power consumption : 25W

Dynamic power: >50W

Stand by Power: <1W

Fuse 0,5A F/T

## **DIMENSIONS AND WEIGHT**

Dimensions: 200 W x 80 H x 260 D mm

Weight: 3 Kg net - Kg. 4 boxed

## **FINISHES**

Brushed Aluminium available in Black, Silver or Gold

# FRONT AND REAR PANEL

## FRONT PANEL OVERVIEW

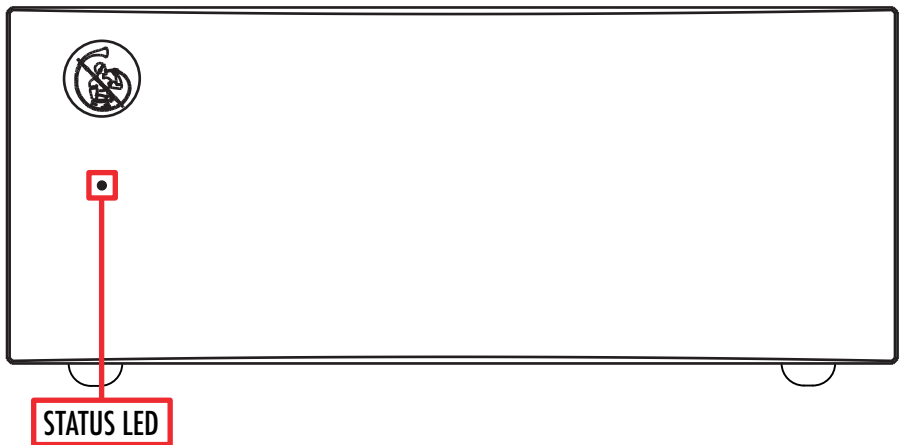

## REAR PANEL OVERVIEW

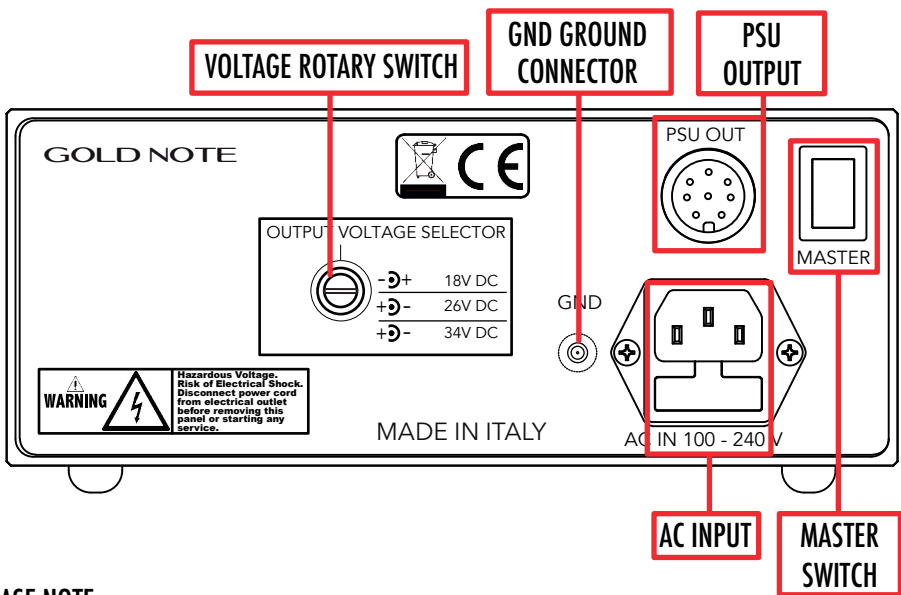

## PLEASE NOTE

The STATUS LED turns to ON position blue light only when PST-10 is connected to supply AC and the MASTER SWITCH is ON.

# SET-UP PST-10

## IMPORTANT:

PST-10 must be connected only to Gold Note turntables with synchronous 12V motors. There are three different available voltages for Gold Note turntables: 18Volt DC, 26Volt DC and 34Volt DC. **PST-10 must be correctly set-up first, if the turntable is powered with a wrong voltage it will be irremediably damaged.**

## BEFORE CONNECTING PST-10 TO YOUR TURNTABLE

All Gold Note turntables **MEDITERRANEO - GIGLIO - PIANOSA - VALORE PLUS - VALORE LITE**, are equipped with a standard Wall-Wart power supply. **Please verify the voltage written of the Wall-Wart to know how to set-up the PST-10.**





# QUICK START

## PST-10 OUTPUT VOLTAGE SETTING

- 1 Connect only the AC cable
- 2 Turn on the PST-10 with the MASTER SWITCH on the rear panel
- 3 Using the special tool screwdriver act on the VOLTAGE ROTARY SWITCH select the voltage corresponding to the one written on the original Wall-Wart power supply of your turntable as shown in the previous photo. The correct voltage selection is shown by the related LED lighting up.
- 4 The PST-10 is ready to be connected to your turntable via the supplied cable.

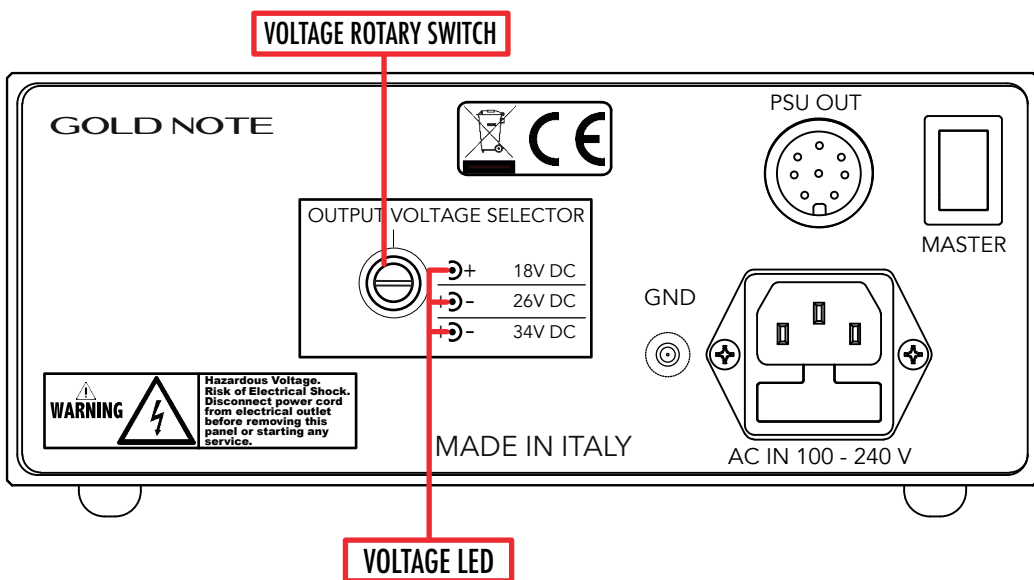

## INSTALLING THE PST-10

1. Connect the PST-10 to the AC power outlet using the supplied power cord then before connecting the turntable select the correct original voltage as above described.
2. Connect the PST-10 to the Turntable using the supplied cable from PSU OUT on PST-10 to the turntable rounded plug.
3. Turn on the MASTER SWITCH on the rear panel of the PST-10 for operating the Turntable from its 33/45 switches.

# CONNECTING PST-10

## CONNECTING PST-10 TO GOLD NOTE TURNTABLES

MEDITERRANEO/GIGLIO/PIANOSA

PST-10

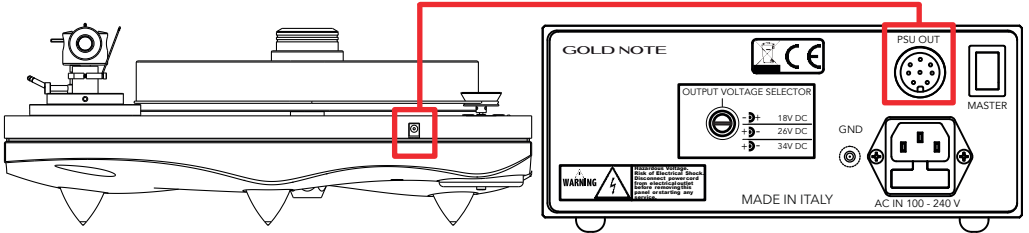

VALORE 425 LITE

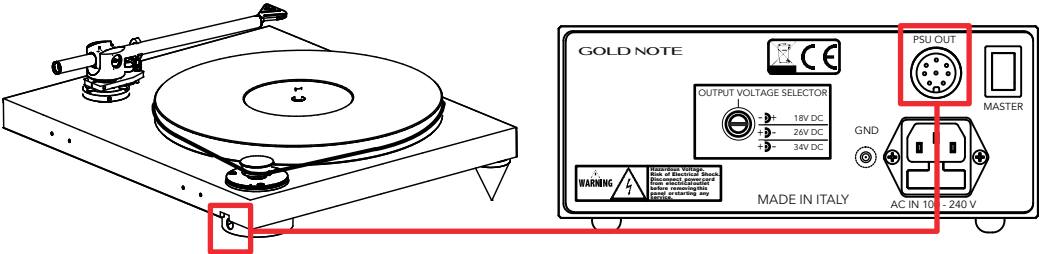

VALORE 425 PLUS - REAR PANEL OF TSC  
(Turntable Speed Control)

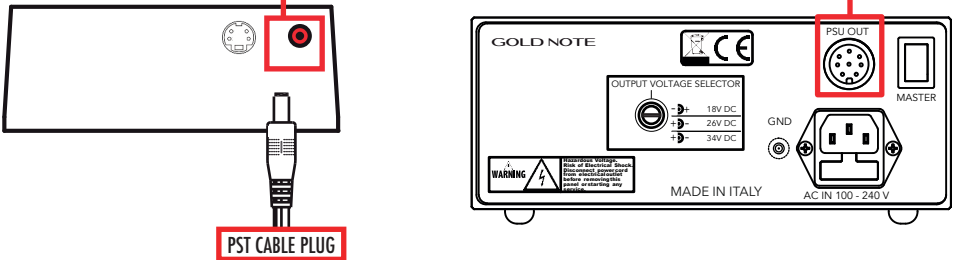

# WARRANTY

## PRODUCT REGISTRATION

We recommend to register the unit on our internet website within 15 days from the purchase at [www.goldnote.it/product-registration](http://www.goldnote.it/product-registration)

If the unit is not registered correctly or has been purchased from a different country of the purchaser home address the unit will not be covered by any warranty and the registration will be refused.

Please note that the warranty does not cover in any case: Tubes, Phono Cartridge Stylus and Batteries.

## WARRANTY

All Gold Note products come with a warranty against defective materials and workmanship.

Any service and inspection must be carried out by a Gold Note dealer or distributor so in case you need any assistance with this product, please contact the seller.

If you experience any problems locating your official Gold Note dealer or distributor, please check our website.

## PLEASE NOTE

Descriptions and technical characteristics may vary at any time and without notice.

## WARNING

Gold Note products should only be opened, serviced and inspected by certified Gold Note technicians and dealers.

Work performed by unqualified personnel may cause serious damage or personal injury. Opening of the product by non-authorised personnel will void the guarantee. In this case, contact your dealer to be advised on how the fault can be solved.

Do not return any object directly to the factory or to the distributor without being authorised to do so.

PROBLEM	CAUSE	SOLUTION
The LED on the front panel is OFF	The POWER CORD is damaged or not plugged in	Ensure that the POWER CORD is not damaged and connect it properly to the power outlet and the AC plug on PST-10
	The MASTER SWITCH is OFF	Turn ON the MASTER SWITCH on the rear panel of PST-10
	Fuse blown	Replace only with same type (0,5A F 5x20mm)
Turntable does not work properly	The PST CONNECTION CABLE is not plugged correctly	Verify the PST-10 CABLE is not damaged and connect it properly to the PSU OUT port on the PST-10 and to the Turntable rounded plug. <b>The Voltage must be selected the same of the original Wall-Wart power supply to avoid damaging the turntable electronics.</b>

For spare parts visit the official Gold Note store at:

[www.akamaiaudio.it](http://www.akamaiaudio.it)

# IMPORTANT SAFETY INFORMATION



## CAUTION!

TO REDUCE THE RISK OF ELECTRIC SHOCK, DO NOT REMOVE COVER (OR BACK). NO USER-SERVICEABLE PARTS INSIDE. REFER ONLY TO QUALIFIED GOLD NOTE SERVICE PERSONNEL FOR SERVICE



## WARNING!

TO PREVENT FIRE OR SHOCK HAZARD, DO NOT EXPOSE THIS APPLIANCE TO RAIN OR MOISTURE

Do not disassemble any part of the product.

Do not use any part of the product for other purposes.

For service and problems of any kind, contact qualified Gold Note personnel.

Protect the product from rain, humidity and keep away from heat sources, electric and electronic motors etc.

The power Chord supplied must be used only on this unit.

Gold Note does not have responsibility for any improper use of this unit.

This appliance has a serial number located on the rear panel.

Please record the model and serial number and retain them for your records.

Serial Number: \_\_\_\_\_

Model: \_\_\_\_\_

# IMPORTANT SAFETY INFORMATION

1. Read these instructions and store them.
2. Heed all warnings.
3. Follow the instructions.
4. Do not use this apparatus near water.
5. Clean only with a dry cloth.
6. Do not block the ventilation openings and install in accordance with the manufacturer's instructions.
7. Do not install near heat sources such as radiators, heat registers, stoves or other apparatus (including amplifiers) that produce heat.
8. Do not defeat the safety purpose of the polarised or grounding-type plug: a polarised plug has two blades with one wider than the other.

A grounding type plug has two blades and a third grounding prong. The wide blade or the third prong are provided for your safety.

If the provided plug does not fit into your outlet, consult an electrician for replacement of the obsolete outlet.

9. Protect the power cord from being walked on or pinched particularly at plugs, convenience receptacles, and the point where they exit from the apparatus.
10. Only use attachments/accessories specified by the manufacturer.

11. Use only with the cart, stand, tripod, bracket, or table specified by the manufacturer, or sold with the apparatus.

When a cart is used, use caution when moving the cart/apparatus combination to avoid injury from tip-over.

12. Unplug this apparatus during lightning storms or when unused for long periods of time.

13. Refer all servicing to qualified service personnel only. Servicing is required when the apparatus has been damaged in any way (such as when the power cord or plug is damaged, liquid has been spilled or objects have fallen into the apparatus, the apparatus has been exposed to rain or moisture) and in any case when the apparatus does not operate normally or has been dropped.





 [goldnote\\_italy](https://www.instagram.com/goldnote_italy)

 [Gold Note Audio](https://www.facebook.com/GoldNoteAudio)

 [Gold Note](https://www.youtube.com/GoldNote)

Akamai S.r.l.  
[service@goldnote.it](mailto:service@goldnote.it)  
[www.goldnote.it](http://www.goldnote.it)