

# GOLD NOTE

il suono italiano

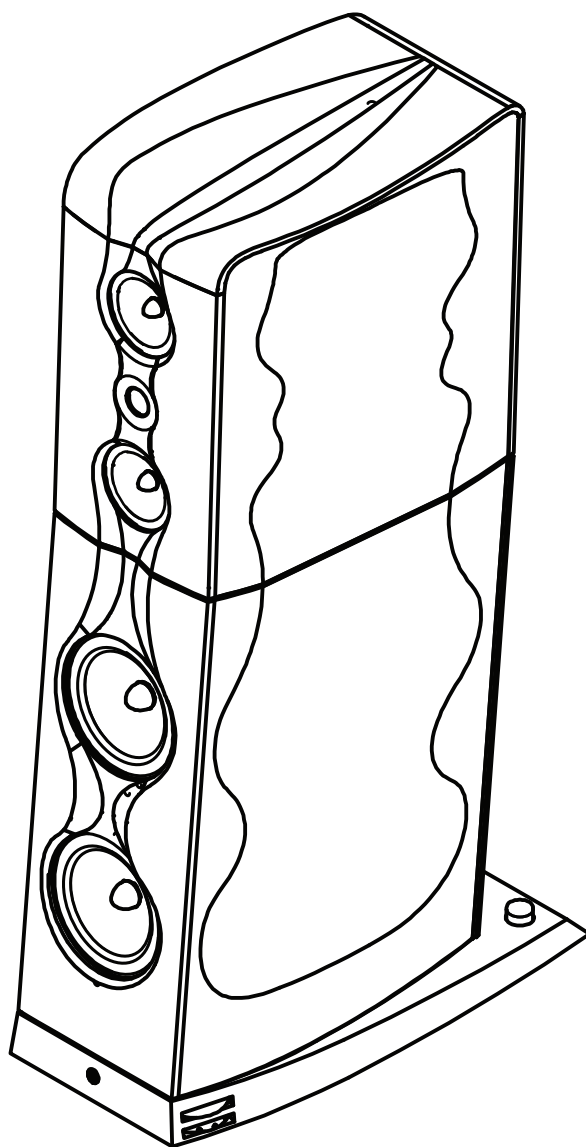

## XS-85

3 WAY MODULAR FLOOR STANDING LOUDSPEAKER

USER MANUAL



# INDEX

PACKAGE CONTENT.....	P. 3
DESCRIPTION.....	P. 4
TECHNICAL SPECIFICATIONS.....	P. 6
UNBOXING AND ASSEMBLY: WOOFER CABINET AND FOOT.....	P. 7
UNBOXING AND ASSEMBLY: MID-HIGH CABINET.....	P. 11
ASSEMBLY: SPEAKER MODULES.....	P. 12
ASSEMBLY AND INSTALLATION: SPEAKER MODULES AND ALUMINIUM GRILLE.....	P. 13
HOW TO ADJUST THE FOOT SPIKES (ADJUSTABLE STAND ONLY).....	P. 14
CONNECTING THE SPEAKERS.....	P. 15
SPEAKER POSITIONING.....	P. 17
PRODUCT REGISTRATION.....	P. 22
FAQ AND TROUBLESHOOTING.....	P. 23
IMPORTANT SAFETY INFORMATION.....	P. 24

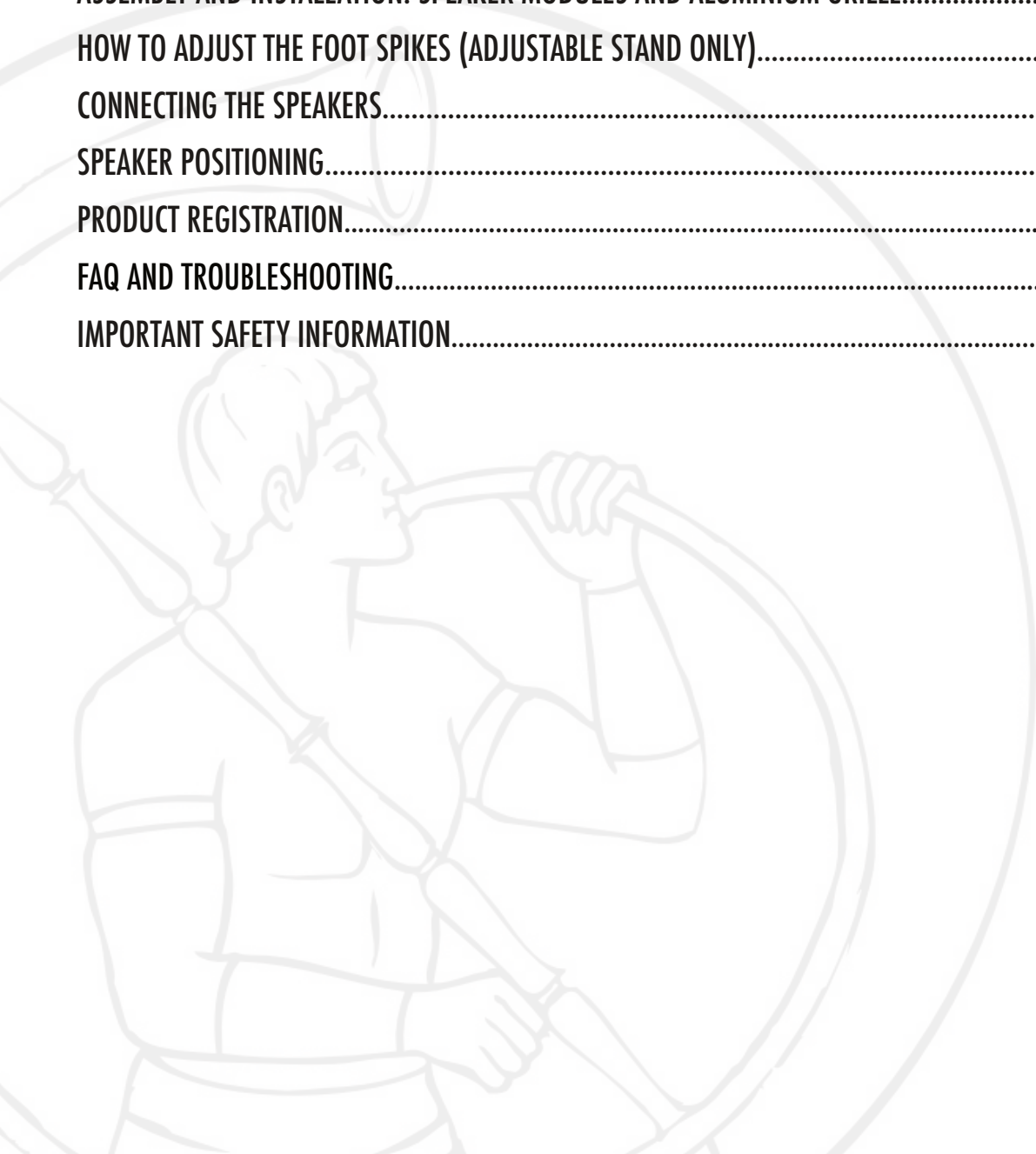

## PACKAGE CONTENT

- 2 XS-85 Loudspeakers
- 2 Loudspeakers covers
- 12 Allen screws M4X40
- 12 Washer M4
- 8 Spike sandblasted + black blackening
- 1 User manual

# DESCRIPTION AND SPECIFICATIONS

## XS DESIGN

The unique design of our flagship speaker is based on ultra-rigid, curved and modular panels. These panels are exclusively hand-crafted in Italy by the most skilled cabinet-maker.

The high-damped cabinet is reinforced with a doubled internal structure and with external wooden multilayer panels to control resonances and improve the audio performance. The cabinets conveniently separate the basses and the mid/highs for a perfect tuning and are coupled with a 3mm aluminium board to increase the rigidity of the entire structure even further.

The woofers are installed in a vented cabinet while the mid/highs are housed in sealed chambers in the upper cabinet. The upper cabinet also features a second open chamber with a massive grille made of solid aluminium to maximize rigidity and reduce internal reflections at the same time.

The loudspeaker features an integrated heavy-duty stand made of steel and wood.

## TWEETER

For this loudspeaker we developed a 28 mm ultra-linear tweeter with an extra-thin and soft silk dome powered by a neodymium magnet featuring an aluminium damping elliptical rear chamber.

This tweeter provides low frequency resonance, minimal harmonic distortion and an exceptional musicality making it a real high-quality and High-End acoustic transducer.

## MIDRANGES

The upper cabinet houses two 150mm ultra-linear drivers that feature high mass phase plugs and Nextel treated paper cones to reach high rigidity and fast natural audio response.

Adaptive rubber surrounds provide an ideal match to the cone over the total frequency range.

The extra large magnet system with long and lightweight CCAW voice coil allows perfect coil excursion and low distortion due to excellent transient response.

Solid copper rings are mounted above and below the T-shaped pole piece to reduce non-linear and modulation distortions and to increase the overload margin.

The driver is completed by an extremely stiff and stable skeleton in aluminium/magnesium to avoid airflow noises and to increase rigidity and lightness.

# DESCRIPTION AND SPECIFICATIONS

## WOOFERS

The XS-85 speakers feature two 220mm ultra-linear slightly horn loaded, light drivers with 18gm mass with Nextel treated paper producing a fast natural audio response in low frequencies.

The bass drivers feature a large magnet design with bumped back-plate: the large and damped platform at the back improves stiffness while the extra-long and light weight CCAW voice coil allows extreme coil excursion, low distortion and excellent transient response.

Giant copper rings mounted above and below the T-shaped pole piece reduce distortion for better overload margin.

High mass phase plugs reduce compression due to temperature variations in the voice coil. Long-term power handling is increased to eliminate resonances from the cavity inside the voice coil former.

## ADJUSTABLE STAND

Optionally available, the exclusive stand featuring hidden spikes designed to help you with fine adjustments for perfect positioning.

PS. The adjustable stand is featured in the images shown on this manual.

## CROSSOVER

The passive Crossover Low-High Dual-Slope with cuts at 200Hz & 2200Hz is a resistive design that enables ultra-linear load to handle any sort of amplification without stressing the power supply, even at a nominal impedance of 4Ω.

The sophisticated triple crossover network, with summing midrange multi-slope design, perfectly integrates the drivers of the array and with anti-resonance thick glass-fibre boards rewards the listener with a close field natural audio experience.

Air winding, hand-made coils and selected audio grade capacitors and exclusive graphite custom GN resistors complete one of the best crossovers available today.

# TECHNICAL SPECIFICATIONS

## SPECIFICATIONS

Frequency response: 30 Hz – 30.000 Hz

Sensitivity: 89dB SPL 2,83V/1m

Nominal impedance: 4Ω semi-resistive

Tweeter: 1" silk dome driver

Midrange: 2x 6" Nextel treated paper cones

Woofers: 2x 9" Nextel treated paper cones

Crossover: 200Hz and 2200Hz @ 12dB/Oct.

Suggested Power Amplifier: min. 30W

Max Power Handling: 300W RMS

## DIMENSIONS AND WEIGHT

Dimensions: 357mm W x 1280mm H x 665mm D

Weight: Kg. 180/pr net - Kg. 200/pr. boxed

# UNBOXING AND ASSEMBLY: WOOFER CABINET AND FOOT

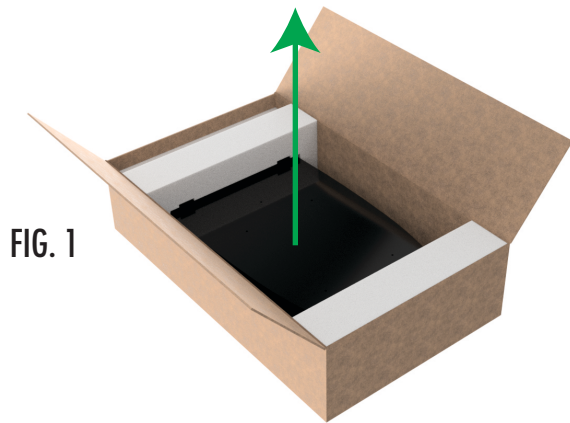

Open the Foot box and gently remove the foot from the box.

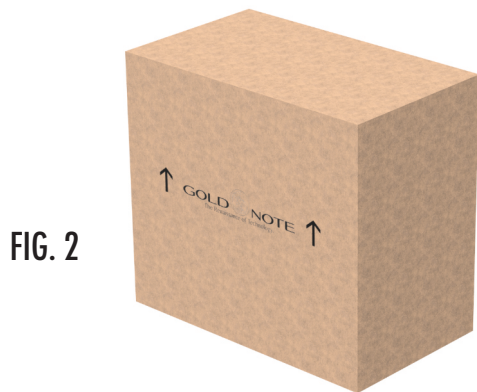

Place the Woofer carton box as shown below.



Open the Woofer carton box from the top.



## UNBOXING AND ASSEMBLY: WOOFER CABINET AND FOOT

FIG. 4

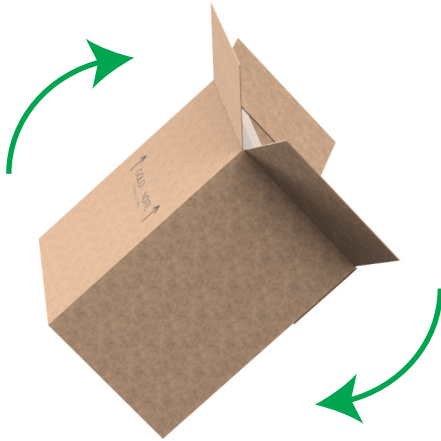

Gently turn the Woofer carton box upside down as shown in the picture.

FIG. 5

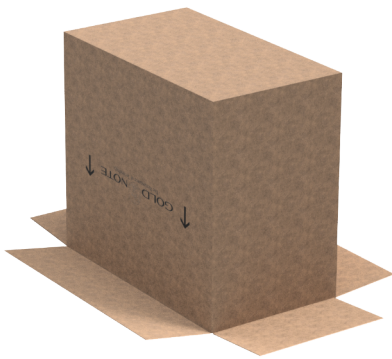

Pay attention to the flaps that must be as shown in **fig. 5**

FIG. 6

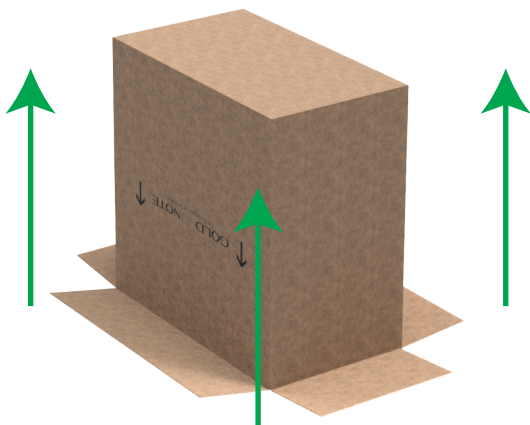

Gently remove the carton box: the Woofer cabinet should now be upside down. After removing the bottom protection, you can go to **fig. 8** being ready to assemble the foot to the Woofer cabinet.

## UNBOXING AND ASSEMBLY: WOOFER CABINET AND FOOT

FIG. 7

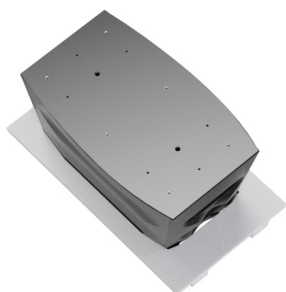
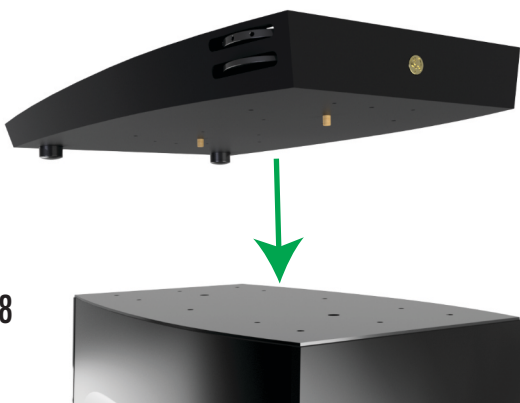

FIG. 8



Take the foot as shown in the picture and use the guides to correctly position the foot on the Woofer cabinet.

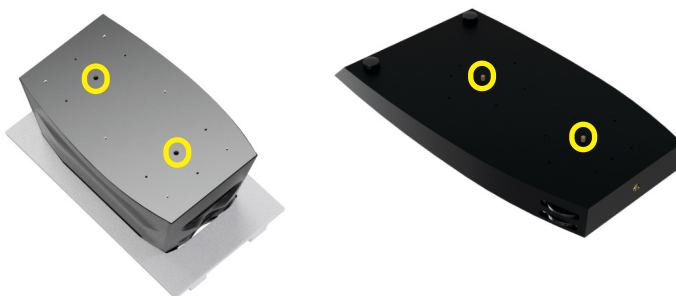

FIG. 9



Insert the supplied Spikes in the threaded rear holes of the metal foot board as shown in the picture.

# UNBOXING AND ASSEMBLY: WOOFER CABINET AND FOOT

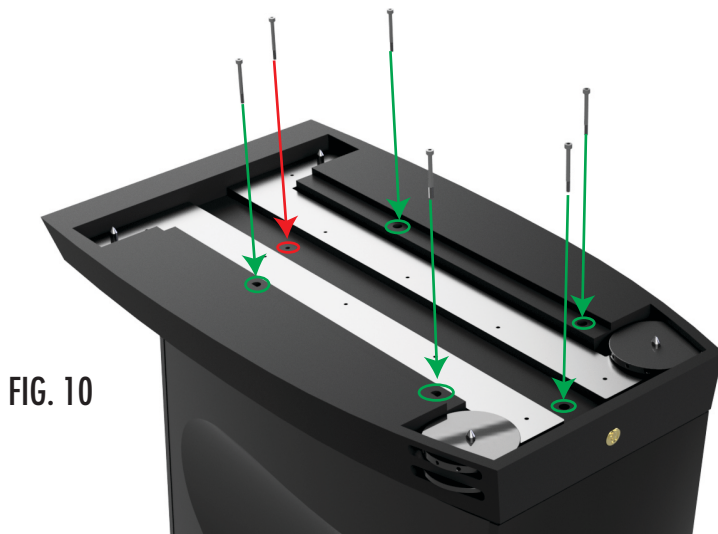
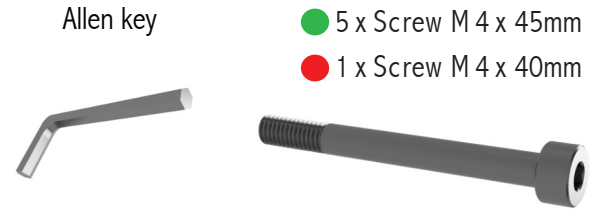

FIG. 10



Secure the foot to the Woofer Cabinet with 6 screws as shown in picture with the allen key supplied.



FIG. 11

Once the Foot is assembled, pay extreme care in turning the cabinet face down as shown in the picture. Make sure to protect it with some soft material to avoid damaging the surfaces.

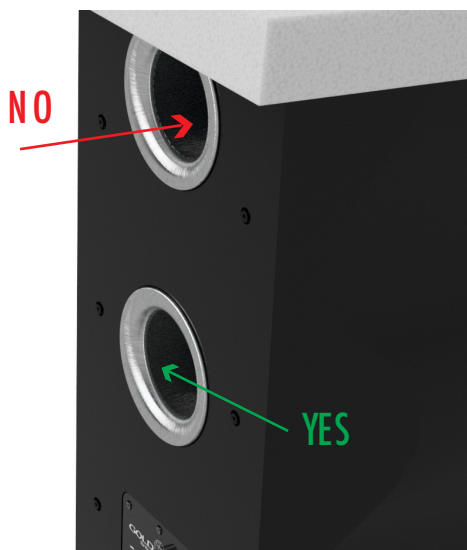
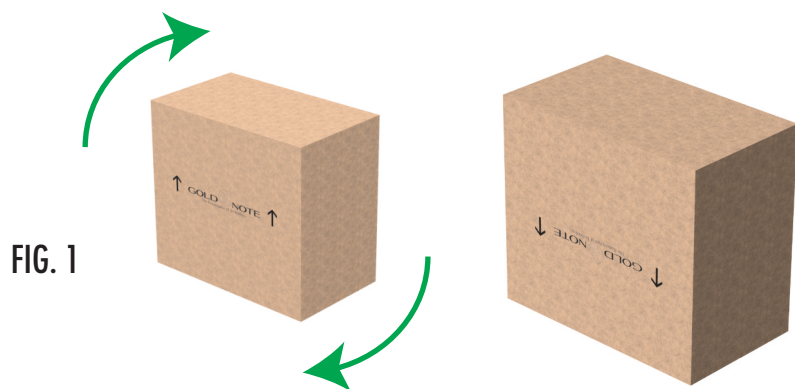

FIG. 12

Do not use the reflex pipes to move the speaker, eventually handle only the external flange to avoid any damage to the reflex assembly.

# UNBOXING AND ASSEMBLY: MID-HIGH CABINET



Gently turn upside down the Mid-High carton box yet **CLOSED**.

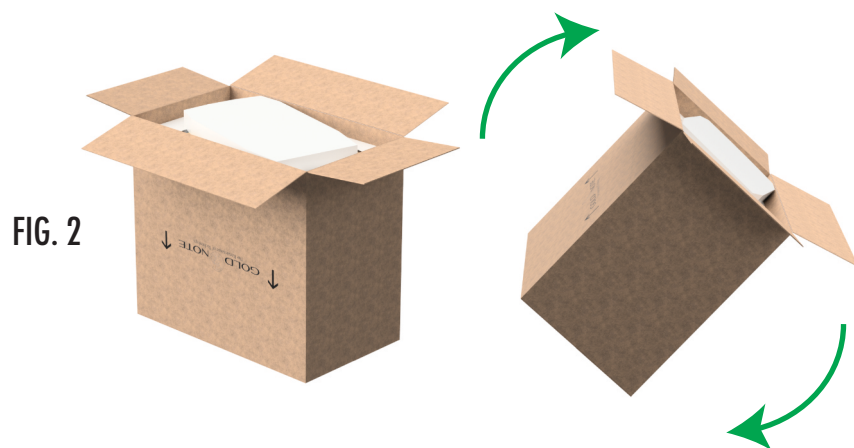

Open the box and take care of the box flaps. Repeat the same operation described for the Woofer Cabinet assembly **fig. 3**

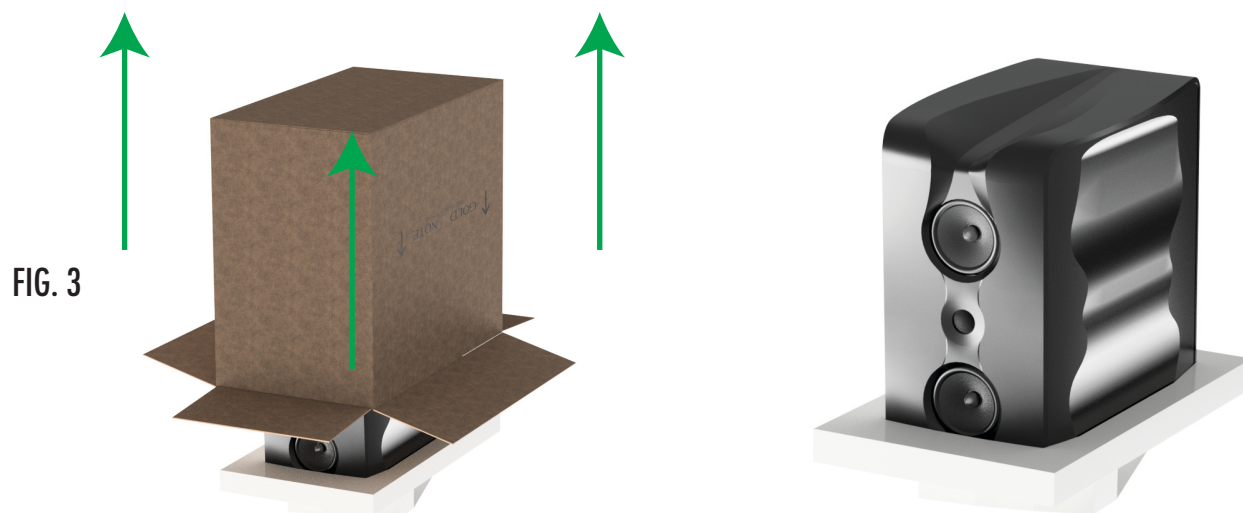

## ASSEMBLY: SPEAKER MODULES



Following the pictures, position the Mid-High Cabinet on the Woofer Cabinet using the guides on the Woofer Cabinet.

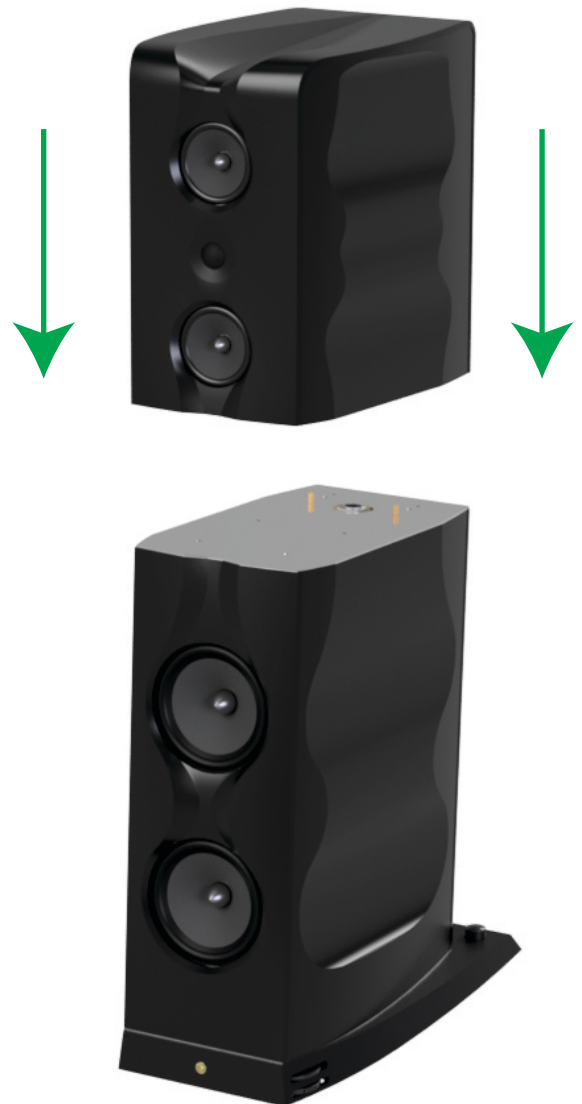
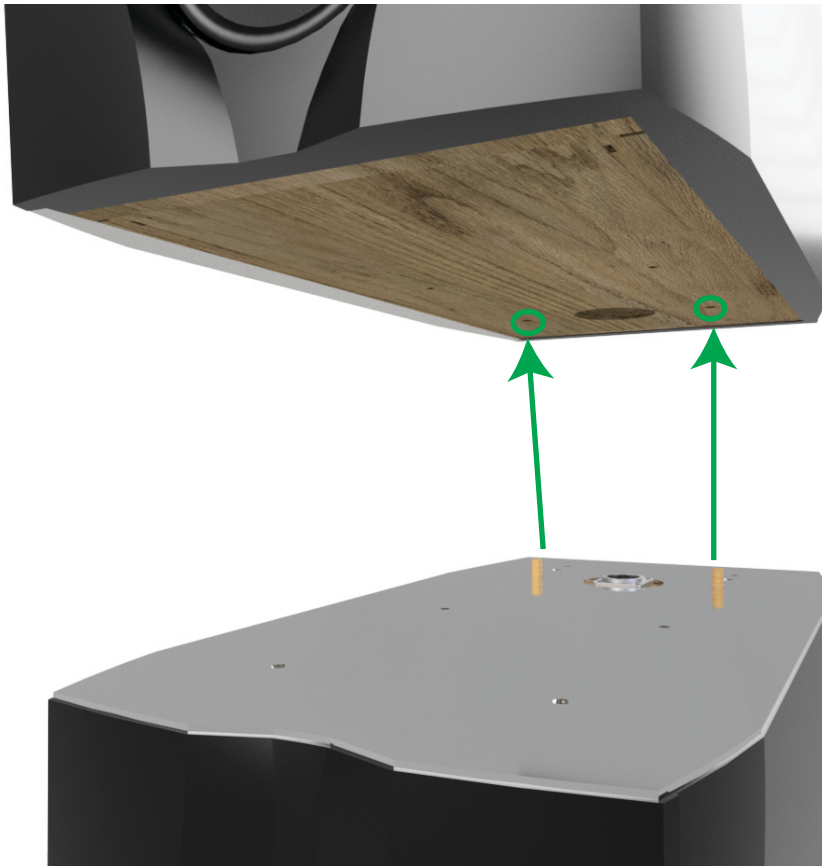

## ASSEMBLY AND INSTALLATION: SPEAKER MODULES AND ALUMINIUM GRILLE

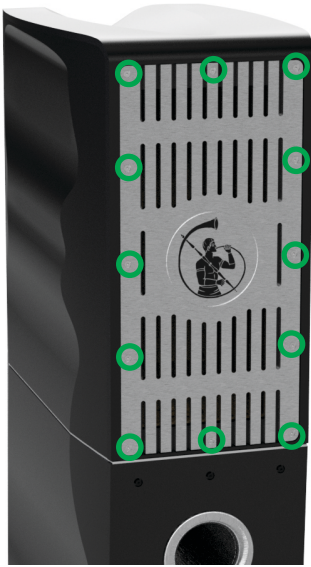

Remove all the screws from the back of the Mid-High Cabinet, then remove the vented aluminium back grille as shown in the picture.



4 x Screw M 4 x 45m m



Secure the Mid-High Cabinet and the Woofer Cabinet to each other with the four M4 Allen screws supplied, as shown in the picture.



Connect the Mid-High speak-on terminal to the same connector of the Woofer Cabinet: Insert it and turn left in order to lock it in place correctly.



Place back the vented aluminium back grille on the Mid-High Cabinet and gently secure all its screws supplied.

# HOW TO ADJUST THE FOOT SPIKES (ADJUSTABLE STAND ONLY)

## FRONT SPIKES (ADJUSTABLE STAND ONLY)

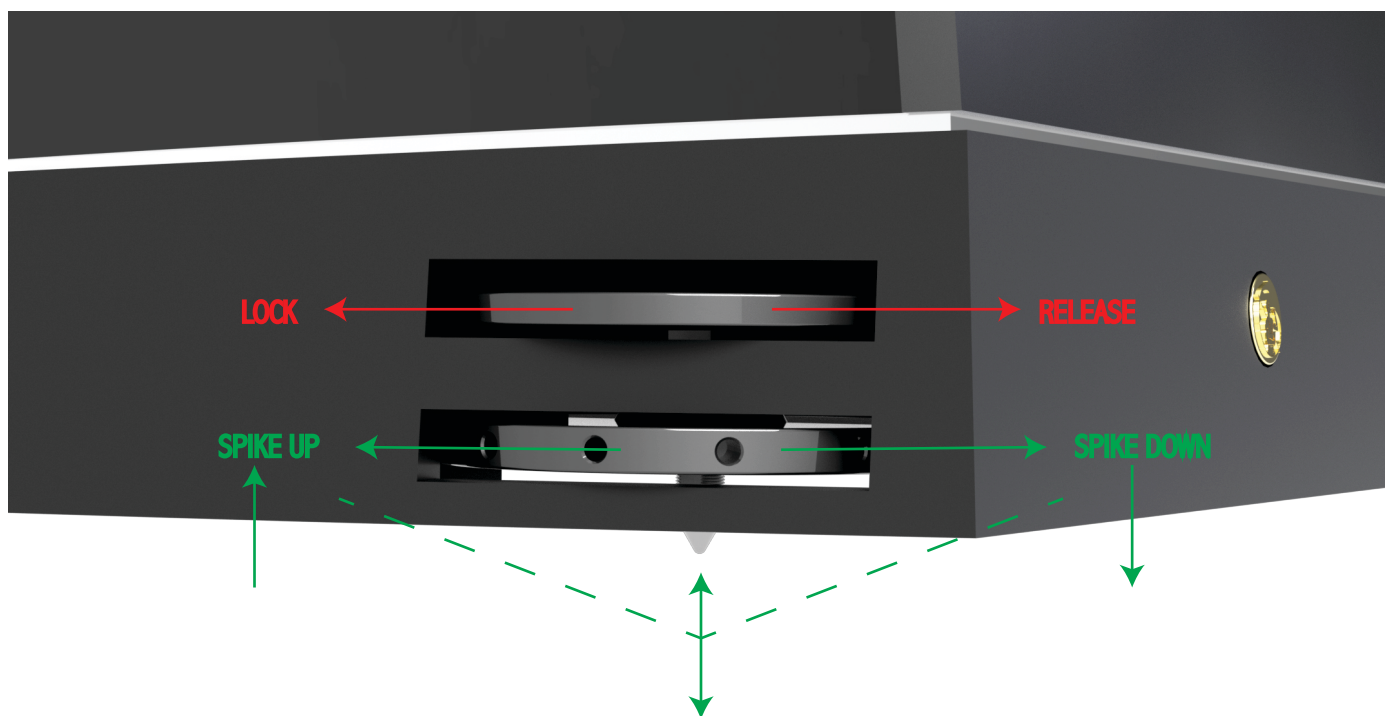

## REAR SPIKES

When the rear spikes are correctly installed, the threaded black aluminium covers supplied can be positioned to secure them firmly to the metal foot boards

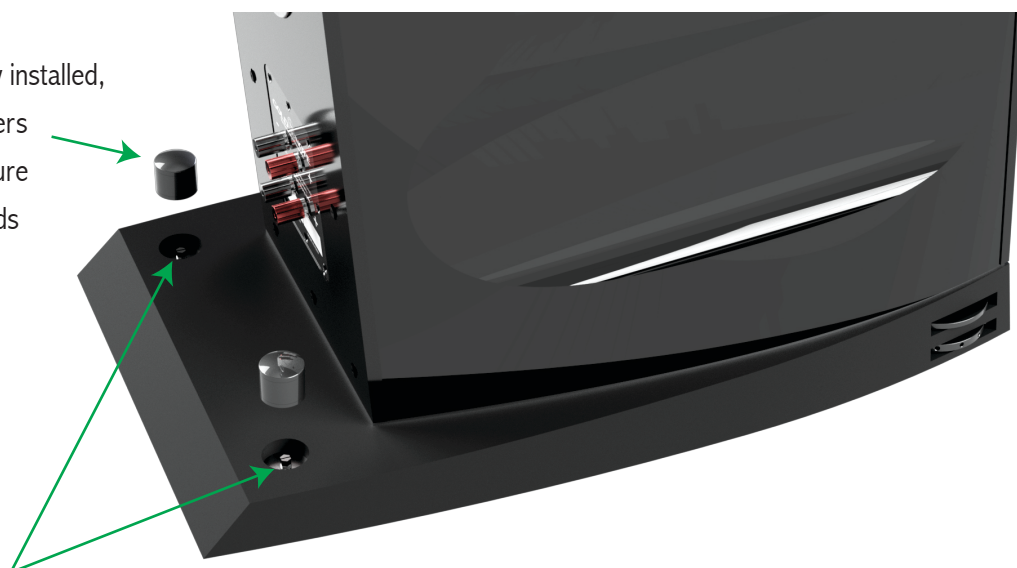

The rear Spikes can be adjusted up and down with a screwdriver or a 5,5mm wrench.

# CONNECTING THE SPEAKERS

## EXAMPLE CONNECTION N. 1

Standard wiring connection (No Bi-Wiring).

Gold Note speakers are all supplied with standard bridge.

Special Exotic Bridge parts of the SIENA BRIDGE ENHANCER line are available on demand

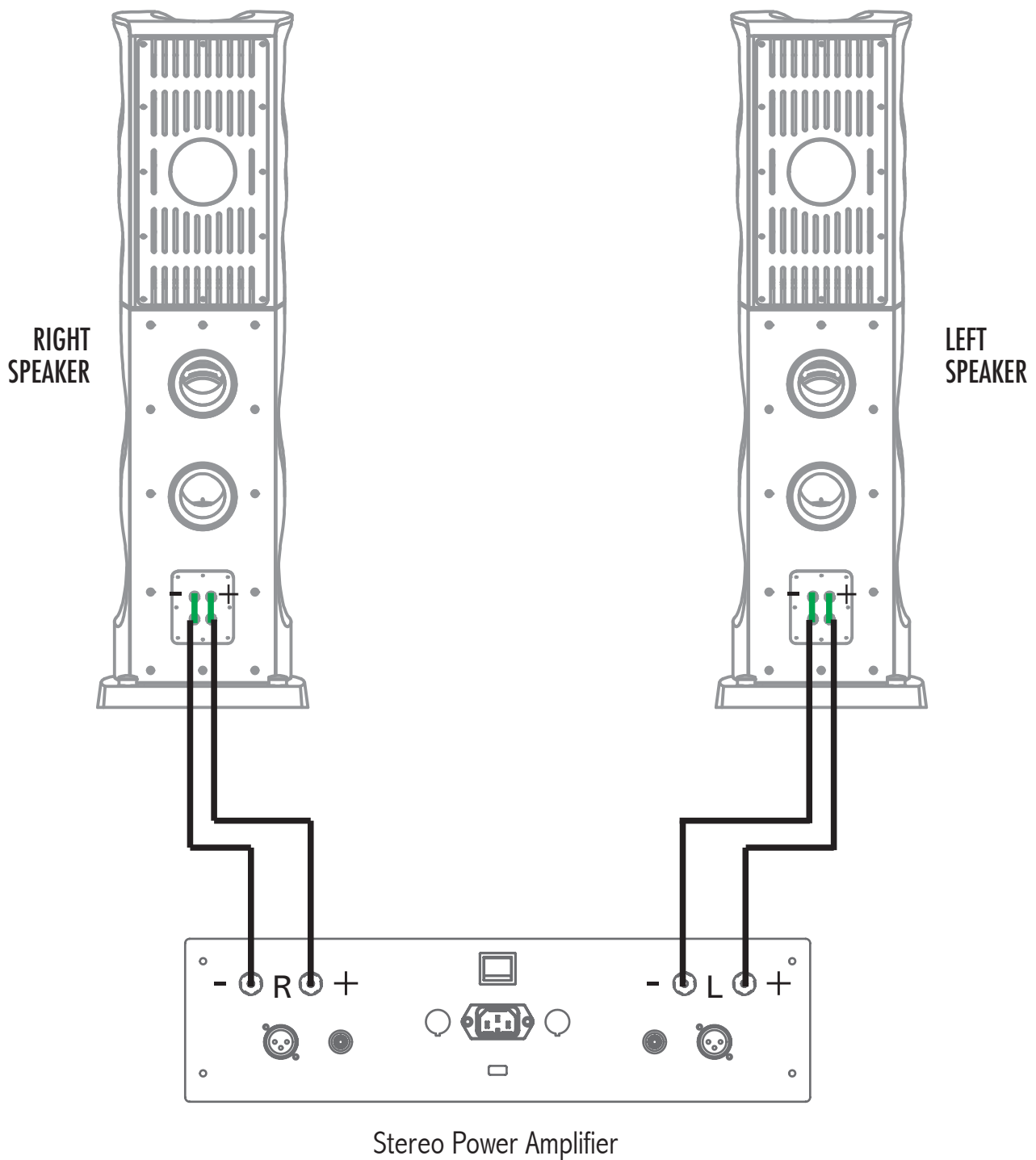



# CONNECTING THE SPEAKERS

## EXAMPLE CONNECTION N. 2

Bi-Wiring Connection

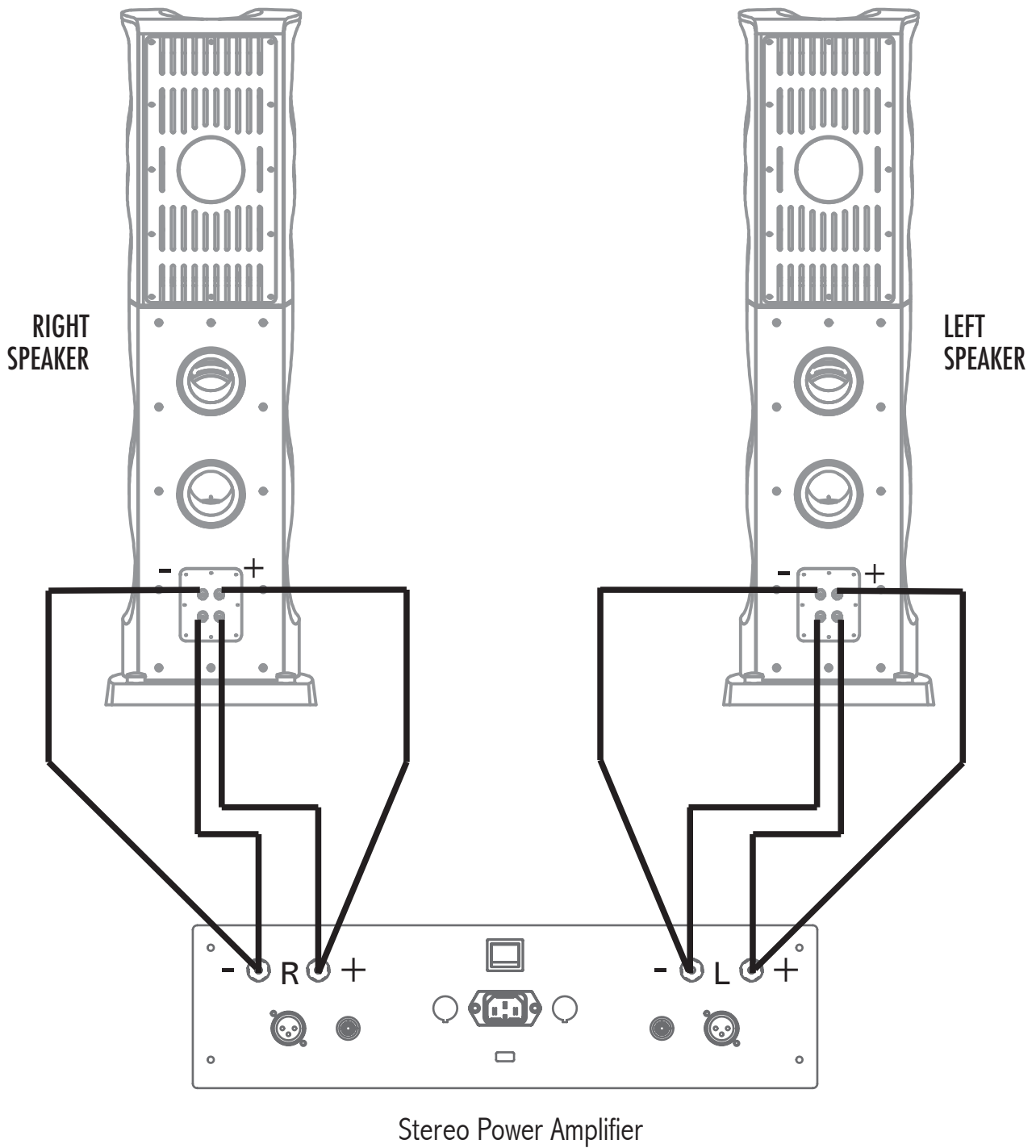

# SPEAKER POSITIONING

Identifying the ideal sound/acoustic room to play an audio system well is not that strictly related to the proportional dimensions of the rooms as many audiophiles believe. The sound played through an audio system is just “Energy diffused in a closed environment” that is all absorbed, reflected and dispersed. The loudspeaker position is the most important aspect because managing the reflections is a key factor to get the best sound. The first two reflections are crucial, after them the energy of the reflection starts being lower and does not particularly affect the sound performance.

The first reflection creates a 25m/s delay. Such delay is not favorable because it creates a disturb overwhelming the sound while the delay in between 40 and 80m/s creates what is called ambience.

Therefore it is very important to reduce the first reflection keeping the speaker as far as possible from the side walls and using some carpets on the floor in front of them is advisable.

A symmetrical position of the speakers in the room, having the same distance from the side and rear walls is also very important and should be implemented when possible. The better the positioning the better the focus and the sound stage will be.

## WALL MATERIAL

Generally, most of the walls are thick therefore there is the best bass extension control as well as good acoustic isolation. Dry walls vibrate quite a bit, therefore they are usually not favorable or should be treated accordingly.

## CEILING

The higher the better. The ideal works between 250 and 360cm having the same regular height.

The vaulted ceiling is quite critical because it works like a magnifier lens increasing the power in specific areas. In case of an attic where typically the ceiling slopes down it is better to position the speakers closer to the lower ceiling and place the listening point in the higher ceiling area.

## FLOOR

Marble floors are the worst because they are extremely reflecting but even the all carpet floors don't work well because they absorb indiscriminately. The best option are wooden floors. In any case, all floors can be easily corrected with a 2/4cm thick carpet placed in front of the speakers.

## SIDE WALLS

Covering the side walls with a carpet is wrong but leaving them naked is not the ideal solution either. Pictures with frames on the walls are ok if they come without glass protection and are placed symmetrically on both sides of the speakers. Eventually some small specific traps could be a good solutions.

# SPEAKER POSITIONING

## REAR WALL

The rear wall does not need to be symmetrical like the side walls but some additional acoustic treatment will be able to diffract the energy of the sound wave which is important to get good results.

A traditional library with books and records is a very good “no cost” solution.

## OPPOSITE WALL

The wall opposite of the stereo system is not that critical. If it is too close to the listening point itself it would be better covering it with some absorbing material or with a thick curtain.

## WINDOWS AND DOORS

They always vibrate. It would be better to not have them situated in the room’s corners or in the middle of the side walls. Treating them with absorbing material could be good but they also must be well closed not waving. Having a door behind the listening point could work fine once opened.

Curtains in front of the windows should be light to avoid stopping too much energy, except for the optional ones behind the listening point.

## FURNITURE

Ideally, avoid using big furniture with glass/many doors. Open shelf furniture is the best.

If possible, avoid placing the table in between the speakers and the listening point because tables tend to reflect heavily the high and mid-frequencies.

## AUDIO RACKS

Though the best position of audio racks usually is not in the middle of the speakers, some special racks such like the Gold Note Galileo can be placed there because its special all curved shape helps diffracting the sound waves very well. If you are using standard racks placed in the middle of the speakers, it is preferable to have rather small ones which enhance a better sound focus.

## SUBWOOFER

A general thinking believes the subwoofer does not have any direct emission of sound so the position is not important. In fact, the energy of the waves generated by the subwoofer creates a sound stage which follows rules similar to the full range speakers therefore the same rules should be applied to it as well.

# SPEAKER POSITIONING

## WIDER STEREO SOUND STAGE SPEAKER POSITION

(for some kind of instrumental music, symphonic orcherstra, etc.)

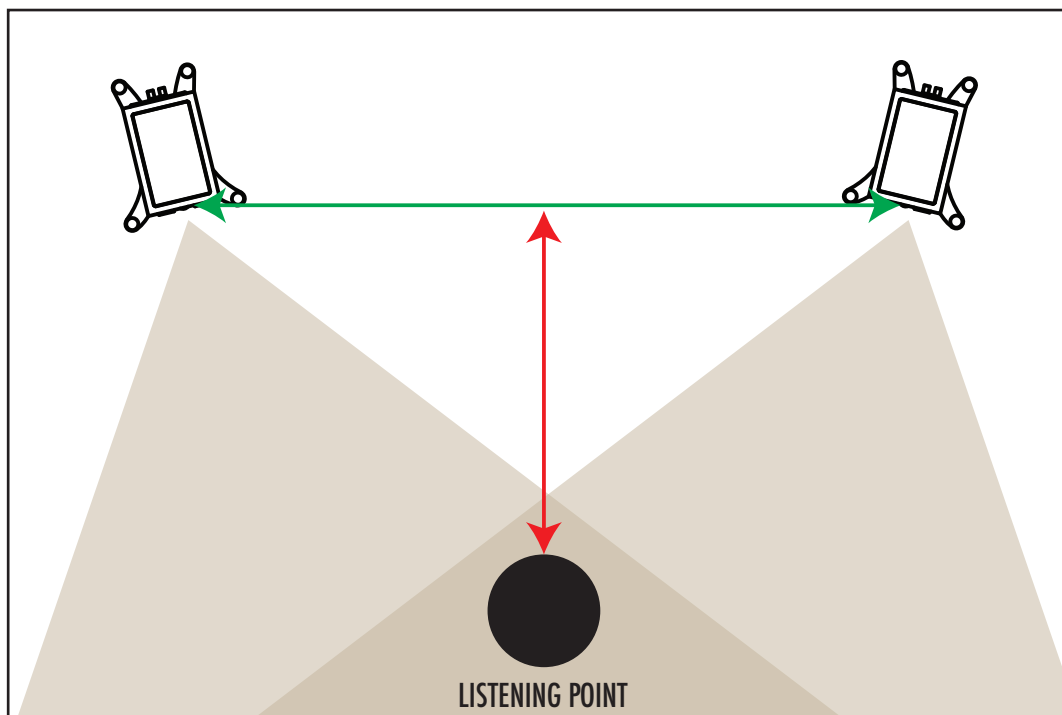

- The distance of both the speakers to the listening point should be the same
- The distance between both the speakers and the side walls should be the same
- The distance between both the speakers and the rear wall should be the same

The more distance there is between the speakers the wider the sound stage will get but less focus will be obtained.

To balance the focus, the speakers can be directed to the listening point as indicated in the images of the pages 18 and 19 of this manual.

# SPEAKER POSITIONING

## NARROWER STEREO SOUND STAGE SPEAKER POSITION

(Optionally for solo instrument music like piano, guitar and voice etc.)

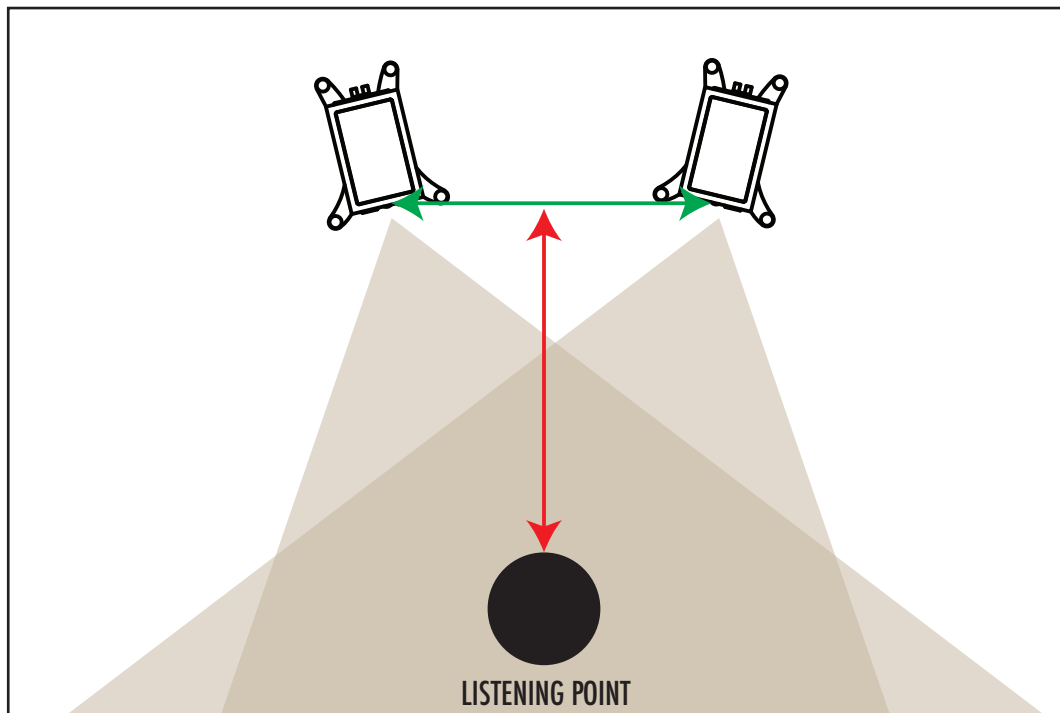

A reduced distance between the speakers will result in a better focus, while producing a less realistic sound stage.

# SPEAKER POSITIONING

## DISTANCE BETWEEN SPEAKER AND LISTENING POINT ORIENTATION

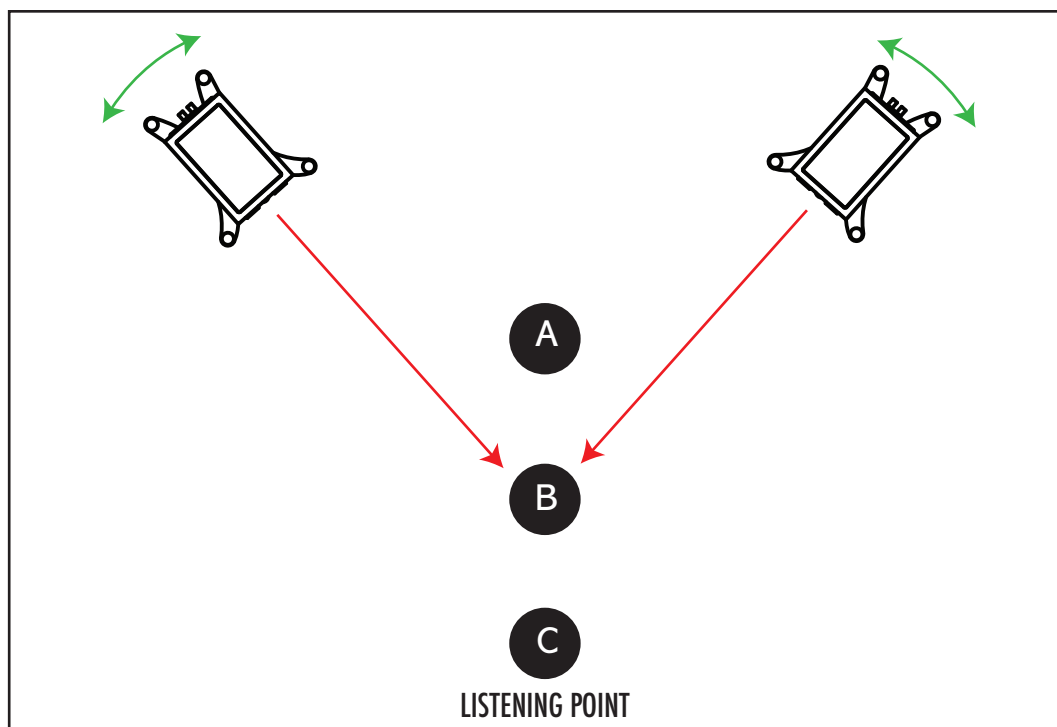

The distance between the speakers should be the same as the one to the listening point. If the distance is shorter, the speaker must be directed to the listening point accordingly (see illustration above).

Empirical tests are necessary to find the right proportion between wide stereo sound stage focus and crispy details.

# PRODUCT REGISTRATION

## **PRODUCT REGISTRATION**

We recommend to register the unit on our internet website within 15 days from the purchase at [www.goldnote.it/product-registration](http://www.goldnote.it/product-registration)

If the unit is not registered correctly or has been purchased from a different country of the purchaser home address the unit will not be covered by any warranty and the registration will be refused.

Please note that the warranty does not cover in any case: Tubes, Phono Cartridge Stylus and Batteries.

## **WARRANTY**

All Gold Note products come with a warranty against defective materials and workmanship.

Any service and inspection must be carried out by a Gold Note dealer or distributor so in case you need any assistance with this product, please contact the seller.

If you experience any problems locating your official Gold Note dealer or distributor, please check our website.

## **PLEASE NOTE**

Descriptions and technical characteristics may vary at any time and without notice.

## **WARNING**

Gold Note products should only be opened, serviced and inspected by certified Gold Note technicians and dealers.

Work performed by unqualified personnel may cause serious damage or personal injury. Opening of the product by non-authorized personnel will void the guarantee. In this case, contact your dealer to be advised on how the fault can be solved.

Do not return any object directly to the factory or to the distributor without being authorized to do so.

# FAQ AND TROUBLESHOOTING

## FAQ

ACTION	DESCRIPTION	HOW TO ADJUST IT
CLEANING THE UNIT	<ul style="list-style-type: none"> <li>The speakers are dirty and need to be cleaned</li> </ul>	<ul style="list-style-type: none"> <li>Use ONLY soft microfibre cloths to sweep out dust and stains (with WATER if necessary)</li> <li>Any acid or alcoholic liquid will irreversibly damage the product's fine aesthetic</li> </ul>

## TROUBLESHOOTING

SYMPTOM	DESCRIPTION	CAUSE	REMEDY
SPEAKER HUMMING PROBLEMS	The speakers hum when the amplifier is connected to the system	<ul style="list-style-type: none"> <li>The unit is not correctly coupled with the Ground on DC</li> </ul>	<ul style="list-style-type: none"> <li>Be sure your area and personal environment are well grounded. Eventually isolate the ground Pin of the power chord plug for verification</li> </ul>
		<ul style="list-style-type: none"> <li>The interconnect input and/or output cables are not shielded.</li> </ul>	<ul style="list-style-type: none"> <li>Be sure to always use shielded cables for the amp connections.</li> </ul>
OUT OF PHASE	The sound does not have a proper focus, even when well positioned	<ul style="list-style-type: none"> <li>The speaker terminals (negative/positive poles) are inverted in some way on the amp or on the speaker.</li> </ul>	<ul style="list-style-type: none"> <li>Turn off the amplifier and rewire the speaker terminals correctly.</li> </ul>
SOME DRIVERS DO NOT WORK		<ul style="list-style-type: none"> <li>Bridges are not well connected to the speaker terminal (Binding Posts).</li> </ul>	<ul style="list-style-type: none"> <li>Connect the bridges properly.</li> </ul>
		<ul style="list-style-type: none"> <li>The speaker cables are not well connected to the speakers.</li> </ul>	<ul style="list-style-type: none"> <li>Connect the cables properly.</li> </ul>
		<ul style="list-style-type: none"> <li>The amplifier does not play music.</li> </ul>	<ul style="list-style-type: none"> <li>Verify the connectivity and that the music is played through a known source.</li> </ul>

For spare parts visit the official Gold Note store at:

[www.akamaiaudio.it](http://www.akamaiaudio.it)



# IMPORTANT SAFETY INFORMATION

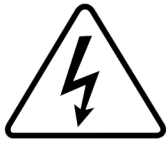

## CAUTION!

TO REDUCE THE RISK OF ELECTRIC SHOCK, DO NOT REMOVE COVER (OR BACK). NO USER-SERVICEABLE PARTS INSIDE. REFER ONLY TO QUALIFIED GOLD NOTE SERVICE PERSONNEL FOR SERVICE

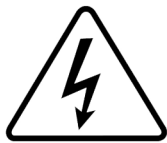

## WARNING!

TO PREVENT FIRE OR SHOCK HAZARD, DO NOT EXPOSE THIS APPLIANCE TO RAIN OR MOISTURE

Do not disassemble any part of the product.

Do not use any part of the product for other purposes.

For service and problems of any kind, contact qualified Gold Note personnel.

Protect the product from rain, humidity and keep away from heat sources, electric and electronic motors etc.

The power Chord supplied must be used only on this unit.

Gold Note does not have responsibility for any improper use of this unit.

This appliance has a serial number located on the rear panel.

Please record the model and serial number and retain them for your records.

Serial Number: \_\_\_\_\_

Model: \_\_\_\_\_

# IMPORTANT SAFETY INFORMATION

1. Read these instructions and store them.
2. Heed all warnings.
3. Follow the instructions.
4. Do not use this apparatus near water.
5. Clean only with a dry cloth.
6. Do not block the ventilation openings and install in accordance with the manufacturer's instructions.
7. Do not install near heat sources such as radiators, heat registers, stoves or other apparatus (including amplifiers) that produce heat.
8. Do not defeat the safety purpose of the polarised or grounding-type plug: a polarised plug has two blades with one wider than the other.

A grounding type plug has two blades and a third grounding prong. The wide blade or the third prong are provided for your safety.

If the provided plug does not fit into your outlet, consult an electrician for replacement of the obsolete outlet.

9. Protect the power cord from being walked on or pinched particularly at plugs, convenience receptacles, and the point where they exit from the apparatus.
10. Only use attachments/accessories specified by the manufacturer.

11. Use only with the cart, stand, tripod, bracket, or table specified by the manufacturer, or sold with the apparatus.

When a cart is used, use caution when moving the cart/apparatus combination to avoid injury from tip-over.

12. Unplug this apparatus during lightning storms or when unused for long periods of time.

13. Refer all servicing to qualified service personnel only. Servicing is required when the apparatus has been damaged in any way (such as when the power cord or plug is damaged, liquid has been spilled or objects have fallen into the apparatus, the apparatus has been exposed to rain or moisture) and in any case when the apparatus does not operate normally or has been dropped.





 [goldnote\\_italy](https://www.instagram.com/goldnote_italy)

 [Gold Note Audio](https://www.facebook.com/GoldNoteAudio)

 [Gold Note](https://www.youtube.com/GoldNote)

Akamai S.r.l.  
[service@goldnote.it](mailto:service@goldnote.it)  
[www.goldnote.it](http://www.goldnote.it)