

SOUNDSTREAM



RUBICON SERIES

RN1.2000D RN4.1400D
RN1.3000D RN5.2000D
RN1.5000D

AMPLIFIERS

THANK YOU AND CONGRATULATIONS

Thank you for your decision to purchase a RUBICON Series mobile amplifier! Our Amplifiers are the result of extensive engineering, testing, and bullet proof construction. Their versatility enables compatibility with optional signal and audio processors. These high quality MOSFET amplifiers may be configured to allow maximum flexibility in designing different types of speaker systems.

DIGITAL CLASS D FULL RANGE AMPLIFIERS

The RUBICON Series are high quality MOSFET amplifiers that are capable of running a system full range, or they may be selected only to power subwoofers. It is important that you closely follow the wiring instructions contained in this Owners Manual so that you get the most from your RUBICON Series mobile amplifier.

CAUTION

Some of our amplifiers are capable of producing a sound pressure level that can cause permanent damage to your hearing system. High sound pressure levels combined with long time listening can give permanent damage to your hearing system. Choose a listening level that is comfortable for your ear. To establish a safe level: Start your volume control at a low setting. Slowly increase the volume until you can hear the music comfortably and clearly, without any distortion. Sudden sound shocks are dangerous.

TECHNICAL FEATURES

Rubicon amplifiers adopt the optimum class D performance, reliability, and footprint of our classic Picasso Nano platform. Once regarded as “dirty power”, class Ds stable performance rivals traditional full range applications. Rubicon Nano’s signal inputs, power/ground, and speaker connections are located on the leading edge of the chassis for an easy, appealing install. All pre-amp & crossover options are conveniently located on the top surface, making adjustment after installation possible. What you might not notice are advances to the digital circuitry, including increased power supply & output stages, & low tolerance surface-mount components. Look for complimentary 4ch, 5ch, & class D monoblocks for any application.

- High Efficiency Class D Performance
 - Hybrid Aluminum Alloy Heatsink for Optimum Dissipation
 - 2-ohm Stereo & 4-ohm Bridged Full Range Operation
 - 1-ohm Minimum Impedance Monoblock Operation
 - Monoblock Bridging Capability for Double Amplifier Application
 - MOSFET Power Supply w/ Audiophile Grade IRTM Transistors
 - Military Grade SMT PCB Maintains Dynamic Performance
 - Direct Short, Thermal, & Overload Circuits Protect Amplifier
 - 200mV-6V Low Level RCA or High Level Signal Input
 - Quick Disconnect High Level Input Wire Harness Included
 - Easy DIY Install Single Sided Terminals & Pre-Amp Controls
 - 4g Power Input Terminals & 8g Speaker Output Terminals
 - Variable 12dB High Pass, Low Pass, & Subsonic Crossovers
 - 12dB Bass Boost Increases Low Octave Harmonics
 - Dash Mount Gain Control Module Included (select models)
-
- Variable low-pass filter (50-500 Hz, 12 dB/octave).
 - Frequency response: 20Hz~22Khz.
 - 4-gauge power and ground wiring is required for installation.

INSTALLATION EXPERIENCE

Installation of RUBICON Series mobile amplifiers requires detailed knowledge of electronics wiring and proper speaker impedance.

We strongly recommend installation by an authorized our dealer.

This Owners Manual only provides general installation and operation instructions. If you have any reservations about your installation skills, please contact your local our dealer for assistance.

PREPARING FOR INSTALLATION

NOTE: The tools listed below may be required for basic installation

- An electric drill with bits
- Philips head and standard screwdrivers
- Wire strippers
- Crimping tool
- VOM (electronic volt ohm meter)
- Heat shrink tubing and gun
- Soldering iron

INSTALLATION PRECAUTIONS

NOTE: Proceed only if you are qualified installer otherwise, let your dealer do it. Always wear protective eyewear when using tools.

- Turn off all stereo and other electrical devices before you begin.
- Disconnect the negative(-) lead from your vehicles battery.
- Locate all fuel lines, brake lines, oil lines, and electrical cables when planning the install.
- Make sure there is at least 2-inches (5 cm) around the air vents on the amplifier.
- When connecting ground points, make sure all paint is carefully scrapped away from the auto body and contact is made with bare metal.
- Use a utility knife to trim away fabric from hole locations before drilling or cutting.
- When running power cables through sheet metal, be sure to use grommets to properly insulate the metal edges from the wire insulation.
- If possible, use tubing through grommets.

MOUNTING THE AMPLIFIER

To keep your RUBICON Series amplifier running at top performance, choosing the proper location is of utmost importance. For this reason the amplifier should be mounted in a location which will allow air to circulate freely.

A clearance of at least 2-inches (5 cm) to all sides of the amplifier is necessary not only for proper cooling, but also for gaining access to the inputs and other variable controls. Be sure that the power and signal cable connections can enter and leave the amplifier in a straight line to avoid the risk of kinked wires causing a malfunction.

MOUNTING LOCATION

Your RUBICON Series amplifier comes with mounting feet that need to be attached to the amplifier prior to installation. Once the feet are in place, use the amplifier as a template and mark the four screw locations. Use caution to make sure there are no objects behind the installation surface that may become damaged during drilling. The amplifier should be protected from exposure to moisture and direct sunlight. The best places to mount your amplifier are: The floor of the trunk, under the driver's seat, or on the back of the rear seat. For alternate installation locations, please consult your dealer.

WARNING

We recommend you to do a careful planning before you start to install this equipment. Choose a location for the amplifier which will allow plenty of air to circulate around the fins on the top of the case. Vertical mounting is to prefer. Do NOT mount the amplifier upside down under the hat rack. In the amplifier case there are double mounting holes to make the installation job easier. The screws supplied in the plastic bag are self drilling when used with an electric screwdriver.

If the surface where you intend to mount the amplifier isn't big enough you can mount the amplifier on a separate fiber board or similar. This will also isolate the amplifier chassies from ground.

NOTE! Before you start drilling, make sure that there are no fuel or brake lines or wiring looms behind where you intend to drill.

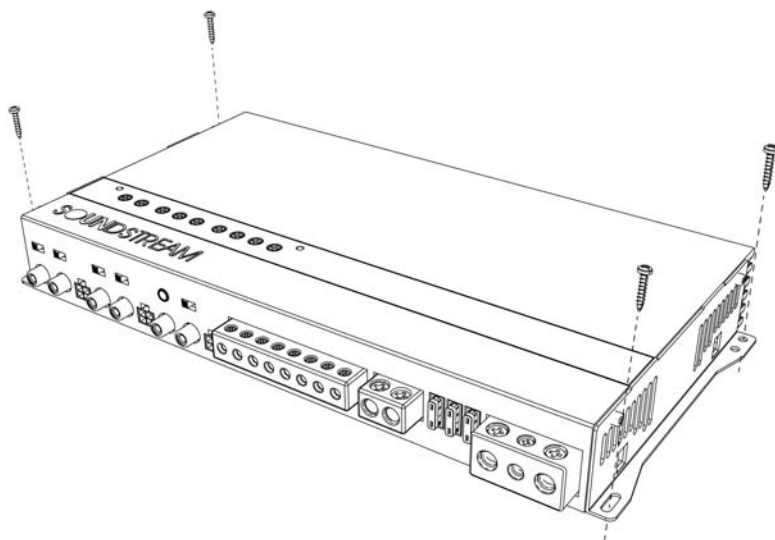

CONTROL PANEL LAYOUT

RN1.2000D

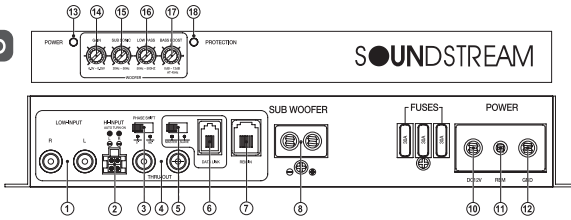

RN1.3000D

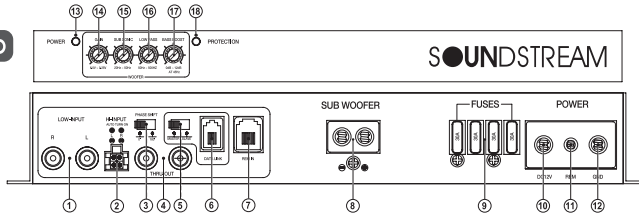

RN4.1400D

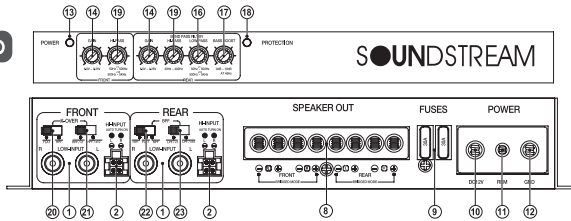

RN1.5000D

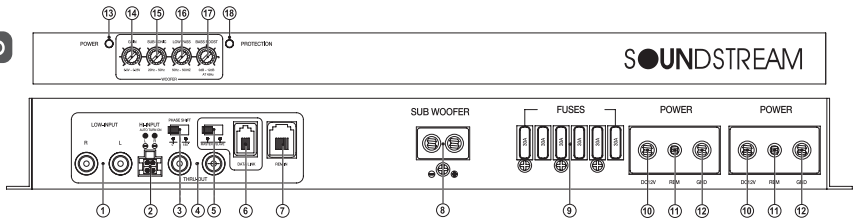

RN5.2000D

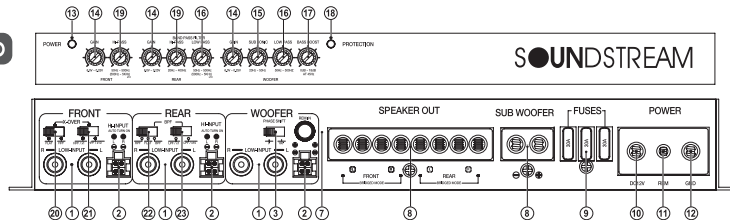

1. LINE IN (RCA)

The RCA style input jacks are for use with source units that have RCA line level outputs. A source unit with a minimum of 250mV is required for proper operation. However, this input will accept levels up to 6Vrms.

2. High Level Input

If you are installing by using a high level, you do not need to connect to the remote because. To hear a better sound quality, you must connect the high level ground wire to the head-unit ground.

3. Phase Shift

Phase Shift Switch (0 or 180 degrees) :Allows you to change the phase of your subwoofer from 0 to 180 degrees to helpcompensate for timing differences between drivers

4. Thru-Out

The LINE OUT allows you to build multiple amplifier systems without having to use splittercords to distribute the signal. Now it is simply a matter of bringing one set of RCAS intothe first amplifier, then using the line out RCA jacks as the feed to the next amplifier.

5. 6. Bridgedable Mode

Master Mode

For bridging into a single speaker load, To do this you must utilize the MASTER/SLAVE switch settings. For the MASTER amplifier, set the switch setting to MASTER. This will route the signal through RCA to the other (slave) amplifier. On the slave amplifier set this switch to the SLAVE position. Refer to Auxiliary Output Configuration section of this guide. Set the PHASE switch on the slave amp, move the phase switch from 0 to 180, exactly opposite of the master amp. Refer to the Phase Switches section of this guide.

Slave Mode

On the slave amplifier be sure to turn off all crossovers. For the speaker connections, connect the positive (+) speaker lead from the speaker to the positive (+) speaker terminal of the master amplifier. On the negative (-) speaker connection, take the negative (-) speaker terminal of the master amplifier and connect it directly to the negative (-) speaker terminal of the slave amplifier. The remaining positive (+) speaker terminal of the slave amplifier must be connected to the negative (-) speaker lead from the speaker. The impedance of the speaker must not exceed 2 Ω . See diagram below.

NOTE: For best results, connect both negative speaker terminals on the master amp to both negative terminals on the slave amp using at least 12 AWG cable.

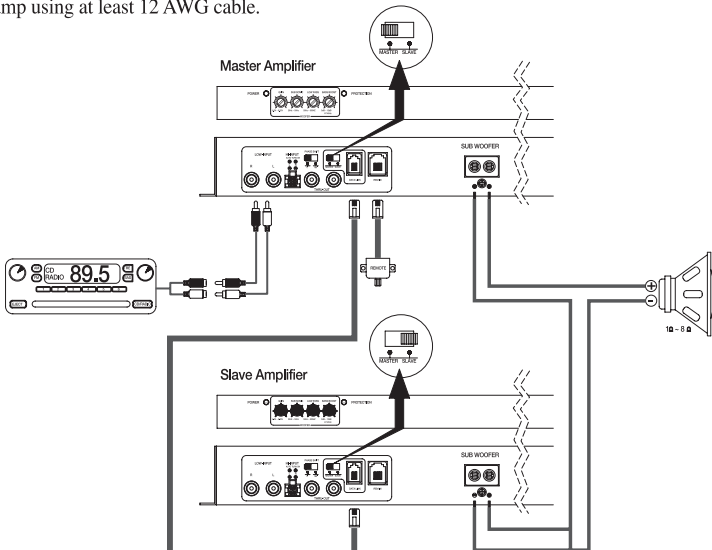

7. Remote Bass Boost Control

This control adjusts the Bass Boost gain for the amplifier's speaker output (0~ +12dB)

*Packed product can be different from the photograph.

8. SPEAKER Terminals

As shown in the wiring diagrams, be sure to observe speaker polarity through the system and speaker impedance. This specially tooled terminal is designed to accommodate up to 10 gauge speaker wire.

9. FUSE

For convenience all RUBICON Series amplifiers utilize common automotive ATC type fuses.

For continued protection in the event that a fuse blows, replace the fuse only with the same value (see specifications page).

10. +BATT (Power Input Connection)

This terminal is the main power input for the amplifier and must be connected directly to the positive (+) terminal of the car battery.

11. REMOTE (Remote Input Connection)

All RUBICON Series amplifiers can be turned on by applying 12 volts to this terminal. This can be found on the rear of the source unit in the form of an electric antenna output, or a remote output.

If this is not available you can wire to the ACC position on the key. An 18 gauge wire is sufficient to run the REMOTE.

12. GND (Ground Input Connection)

A good quality ground is required for your RUBICON Series amplifier to operate at peak performance. A short length of cable the same gauge as your power cable should be used to attaché the ground terminal directly to the chassis of the vehicle.

13. POWER Indicator

The GREEN when the power is on.

14. Gain adjustment control

The input level can be adjusted with this control. Turn it in the clockwise direction when the output level of the car audio unit seems low.

15. SUB Sonic Filter

Variable subsonic filter (20Hz ~50Hz)

The subsonic filter will roll off all of the unwanted frequencies below 20Hz ~50Hz.

This will allow the amplifier to use that wasted power on the audible bandwidth.

16. Low pass Filter

Sound stream Rubicon amplifier has an internal variable low pass filter. It can be set from 50 up to 500 Hz. It also has that can be set from 500 up to 5KHz.

17. Bass boost level control

Turn this control to boost the frequencies around 45 Hz to a maximum of 12 dB.

18. Protection Indicator

When the PROTECTOR is activated, the indicator lights up in red. When the PROTECTOR is activated refer to the Troubleshooting Guide.

19. High pass Filter

Sound stream Rubicon amplifier has an internal variable High pass filter. It can be set from 50 up to 500 Hz. It also has that can be set from 500 up to 5KHz.

20. High pass/Flat selector switch

When the switch is in the HPF position, the filter is set to High-pass. it is activated High pass potentiometer in top control.

21. HPF X10 selector switch

When the switch is in the x10 position, can be set from 50 up to 500 Hz. It also has that can be set from 500 up to 5KHz.

22. High pass/ Flat/Low pass selector switch

It is activated in each of the positions in top control.

23. LPF X10 selector switch

When the switch is in the x10 position, can be set from 50 up to 500 Hz. It also has that can be set from 500 up to 5KHz.

✦ Band Pass Filter

Bandpass filters are used primarily in wireless transmitters and receivers. The main function of such a filter in a transmitter is to limit the bandwidth of the output signal to the minimum necessary to convey data at the desired speed and in the desired form. In a receiver, a bandpass filter allows signals within a selected range of frequencies to be heard or decoded, while preventing signals at unwanted frequencies from getting through.

A band-pass filter is a Filter which is designed to pass signals only in a certain band of frequencies while attenuating all signals outside this band.

A band-pass filter works to screen out frequencies that are too low or too high, giving easy passage only to frequencies within a certain range.

Band-pass filters can be made by stacking a low-pass filter on the end of a high-pass filter, or vice versa.

✦ Remote Subwoofer Level Control

This input allows you to add remote that will allow you to control the subwoofer output of your Rubicon amplifier from your dashboard. and to adapt the amplifier to all kind of signal sources with varying levels there are a level control provided on the amplifier next to the phone jacks. It should not be used as volume controls. Start with a "12 o clock" setting of the level controls. If you set the head unit volume to 75% of maximum you should achieve a good sound without distortion. Find a point of the level setting where the distortion is just discernible. At this point slightly reduce the control.

✦ How to Installation

The dash control mounts with two screws, which attach to the underside of the dashboard. Slide under the dash and place the dash control in its mounting position, mark the two mounting holes, drill pilot holes, and secure with two screws.

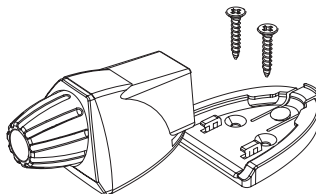

POWER & SPEAKER CONNECTION

Power & Speaker connection

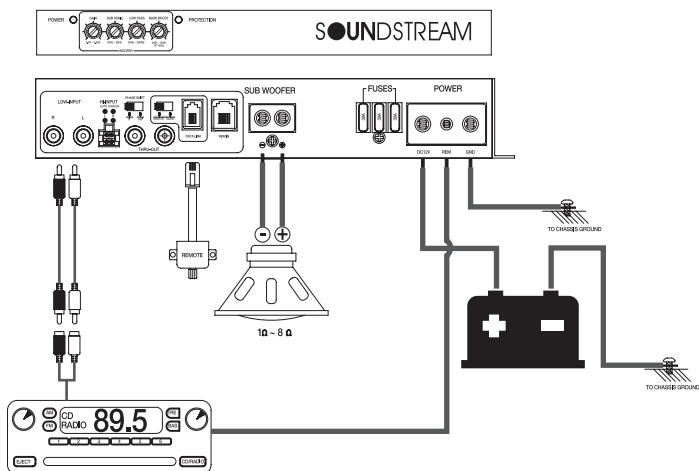

Power & Speaker connection

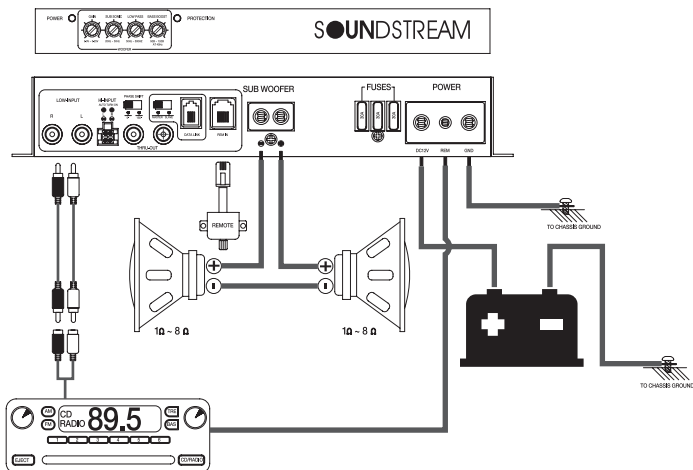

RN1,2000D			
400Wx1ch	4Ohm.	14,4V 100Hz RMS.	
600Wx1ch	2Ohm.	14,4V 100Hz RMS.	
900Wx1ch	1Ohm.	14,4V 100Hz RMS.	
2,000W	MAX POWER		

POWER & SPEAKER CONNECTION

Power & Speaker connection

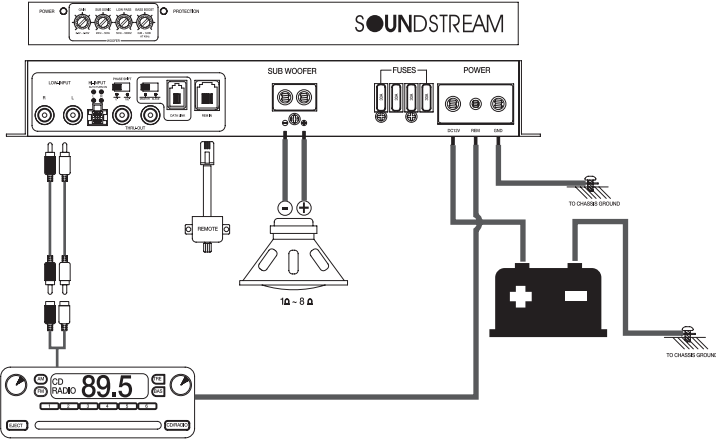

Power & Speaker connection

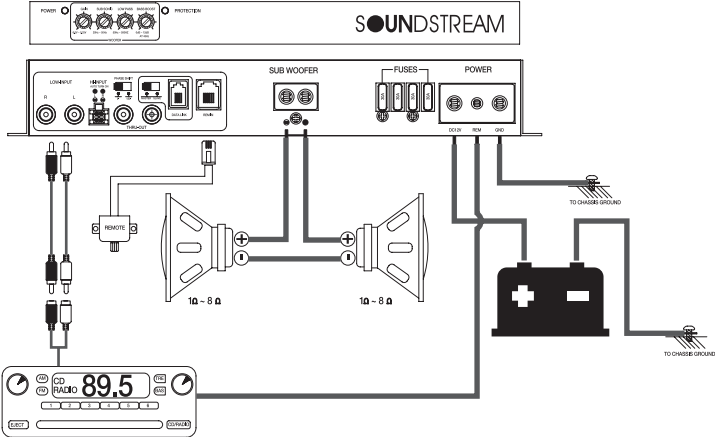

RN1.3000D		
600Wx1ch.	4Ohm.	14,4V 100Hz RMS.
900Wx1ch.	2Ohm.	14,4V 100Hz RMS.
1,500Wx1ch.	1Ohm.	14,4V 100Hz RMS.
3,000W	MAX POWER	

POWER & SPEAKER CONNECTION

Power & Speaker connection

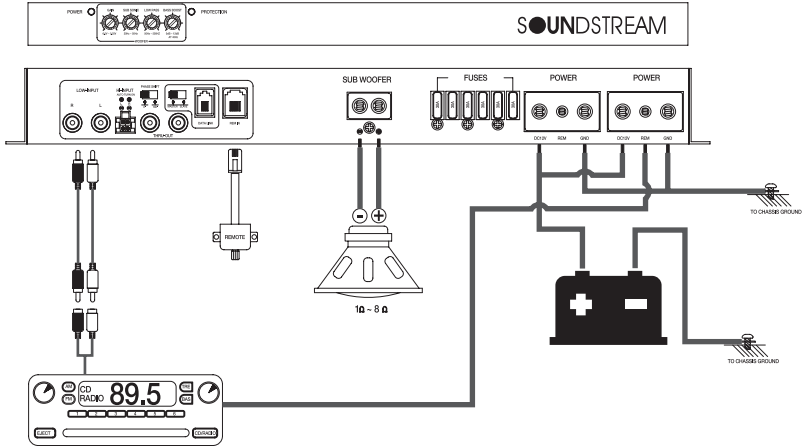

Power & Speaker connection

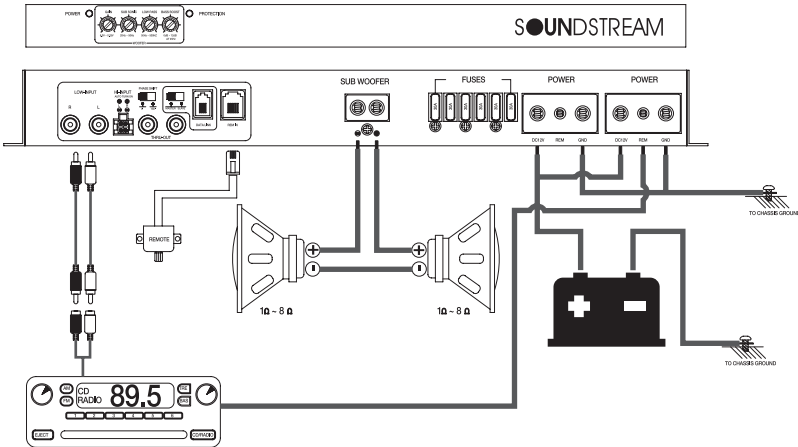

RN1.5000D		
1,000Wx1ch.	4Ohm.	14.4V 100Hz RMS.
1,500Wx1ch.	2Ohm.	14.4V 100Hz RMS.
2,500Wx1ch.	1Ohm.	14.4V 100Hz RMS.
5,000W	MAX POWER	

POWER & SPEAKER CONNECTION

Power & 4 Ohm Stereo connection

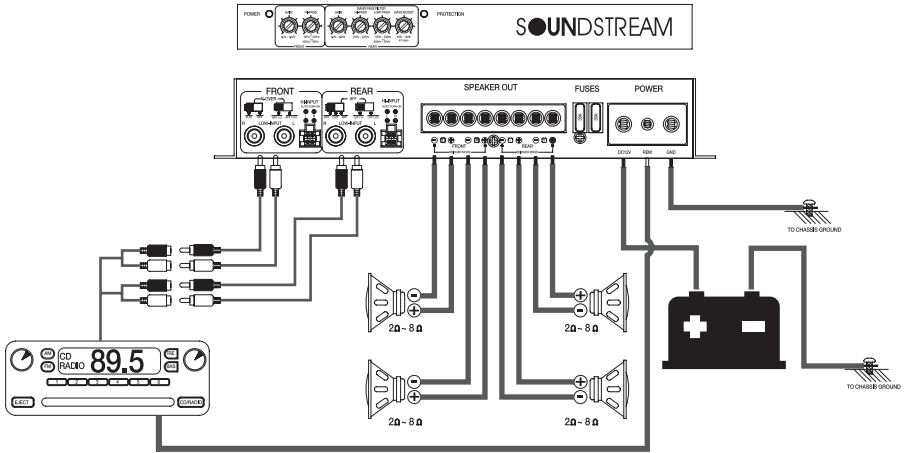

Power & 4 Ohm Bridged connection

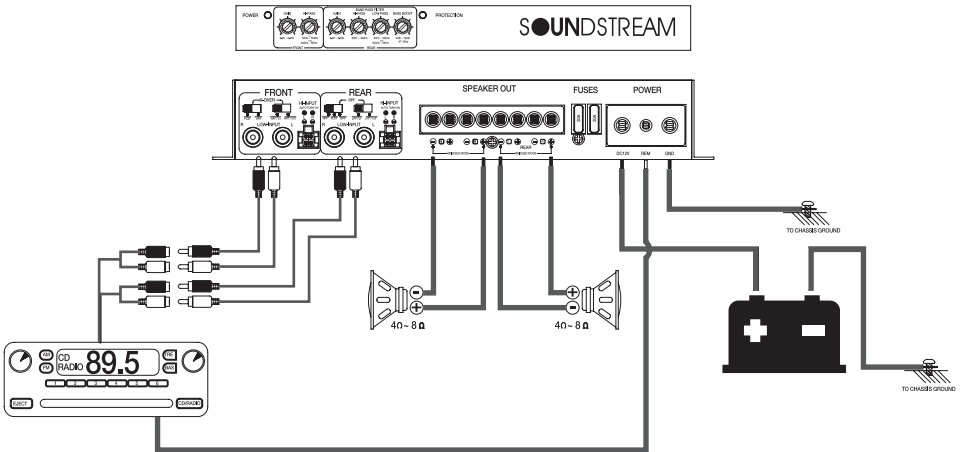

RN4.1400D		
125Wx4ch.	4Ohm.	14.4V 1KHz RMS.
175Wx4ch.	2Ohm.	14.4V 1KHz RMS.
350Wx2ch.	4Ohm.	14.4V 1KHz RMS.
1,400W	MAX POWER	

POWER & SPEAKER CONNECTION

Power & 4 Ohm Stereo connection

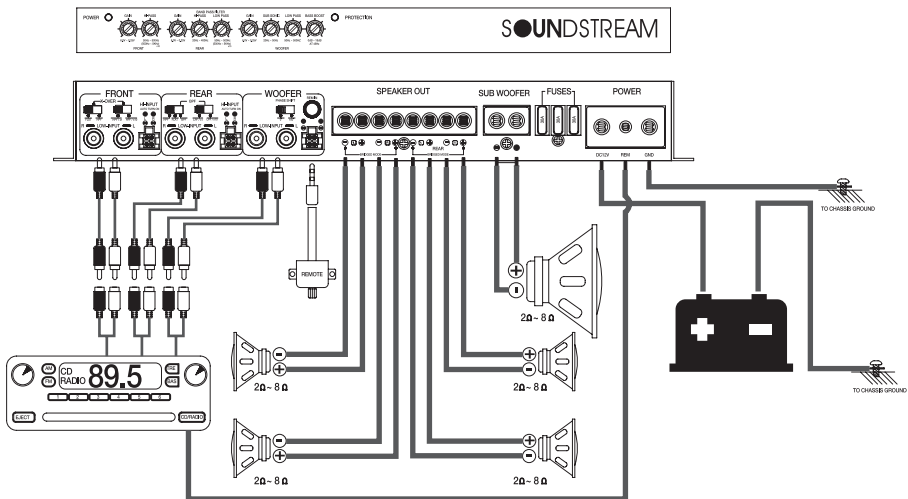

Power & 4 Ohm Bridged connection

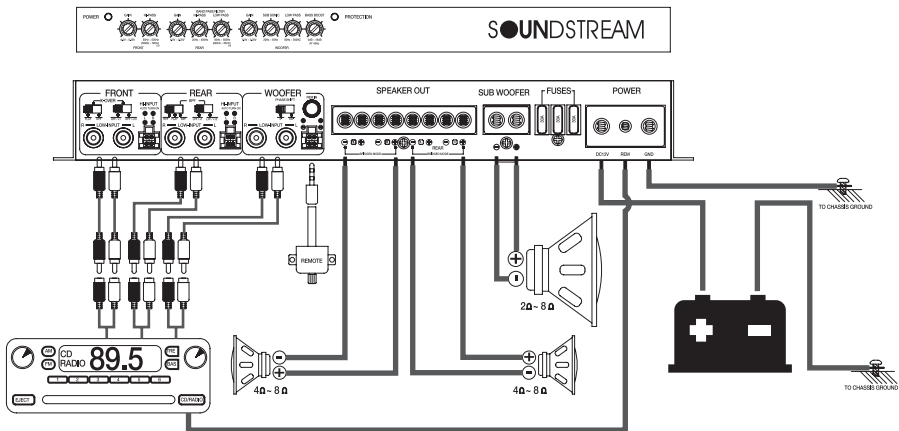

RN5.2000D		
75Wx4ch.	4Ohm.	14.4V 1Khz RMS.
125Wx4ch.	2Ohm.	14.4V 1Khz RMS.
250Wx2ch.	4Ohm.	14.4V 1Khz RMS.
300Wx1ch.	4Ohm.	14.4V 100Hz RMS.
500Wx1ch.	2Ohm.	14.4V 100Hz RMS.
2,000W	MAX POWER	

These amplifiers are designed to work within a 10 to 16.8 volt DC range. Before any wires are connected, the vehicles electrical system should be checked for correct voltage supply with the help of a voltmeter.

First, check the voltage at the battery with the ignition in the OFF position. The voltmeter should read no less than 12V. If your vehicles electrical system is not up to these specifications, we recommend having it checked by an auto electrician before any further installation. Once the vehicle is checked, make certain the correct cable size is used. We recommend using as large a gauge cable as possible, use the Power Cable Selection Chart to calculate the correct power wire size for your application.

Power

This amplifier should be wired directly to the vehicle battery using the appropriate size cable. Start at the vehicle battery and run the power cable through to the amplifier. Avoid running the power cable over engine components and near heater cores. The use of an inline fuse or circuit breaker is a must; this will prevent the risk of a potential fire caused by a short in your power cable. Connect the fuse holder or circuit breaker as close to the battery positive (+) terminal as possible (no farther than 18" from the battery). This fuse or circuit breaker should be no greater than the sum of the fuses found on the chassis of your amplifier (also see specifications chart). You may now connect the cable to the battery, but remember to leave the fuse out or circuit breaker "off" until all other cable connections are made.

Ground

When grounding your amplifier, locate a metal area close to the amplifier that is good source of ground (preferably the floor pan). Once again, investigate the area you wish to use for electrical wires, vacuum lines, and brake or fuel lines. Use either a wire brush or sandpaper to eliminate unwanted paint for better contact of the ground. Secure the ground cable to the body using a bolt, star washer and nut. Spread silicon over the screw and bare metal to prevent rust and possible water leaks.

Now it's time to connect the power and ground cables to the amplifier. Cut both cables to length. Strip off 1/2 -inch (12mm) of the insulation so that the bare wire fits all the way in the terminal block on the side panel of the amplifier, seating it firmly so no bare wire is exposed. Use a Philips (cross) type screwdriver to loosen the +BATT and the GND connections on the amplifier. Insert the ground first, and then the +12V and please make sure that you place them into the correctly marked terminals. Then tighten the screws down securely.

Remote

This terminal must be connected to a switched +12V source. Typically, remote turn-on leads are provided at the source unit that will turn on and off the amplifier in correspondence with the source. If the source unit does not have a remote turn-on lead, then a power antenna wire can be used. If neither of these leads is available at the source unit, then a switched +12V supply must be used, like the ACC, +12V.

REMOTE WIRE

Some signal cables include a thin wire for remote amplifier start. High quality cables normally requires a separate wire for this. Connect between the head units remote cable (often the same cable that 's used for automatic power antennas) and the REM-terminal on the amplifier.

NOTE! If you want to start more than one amplifier using the remote output, the current load might be too high for som head units. High currents may damage the head unit, check in the manual for the head unit. Sometimes you must add a relay to the remote circuit that takes care of the higher current. If you are uncertain of how to connect the relay, ask your local DLS dealer for advice.

SPEAKER CONNECTION

Always use high quality speaker cables . Connect the speaker + (marked with + or a red dot) to the amplifier + terminal, and the speaker

When fitting the cables to the terminals, remove only 10 mm of the insulation. Twist the wire strand together and insert the wire after loosening the terminal screw. Do not over tighten as this can cut the cable strands. To prevent the cable insulation from beeing damaged over sharp metal edges we recommend the use of cable protection tubes or similar. A damaged cable insulation could cause serious damage to the amplifier not covered by any guarantee.

SPEAKER POLARITY CHECK

All speakers in a car audio system should be connected in phase (the same polarity). All speaker cones must move in the same direction. Out of phase speakers will cause a lack of bass, and a poor stereo soundstage.

TROUBLESHOOTING TIPS

Problem	Solution
Power LED not ON	With a Volt Ohm Meter (VOM) check: <ul style="list-style-type: none"> • +12 Volt power terminal (should read +12 to +16VDC). • Remote turn-on terminal (should read +12 to +16VDC). • Ground Terminal.
Power LED is GREEN, no output	<ul style="list-style-type: none"> • Check RCA connections. • Test speaker outputs with known good speaker. • Substitute known good Source Unit. • Check for signal on the RCA cable with VOM in AC position.
Protection LED is ON, no output and 1. Amp is VERY HOT 2. Amp shuts down ONLY when the vehicle is running 3. Amp plays at very low volume	<ul style="list-style-type: none"> • Thermal protection is engaged. Check for proper impedance at speaker terminals. Also check for adequate air flow around the amplifier. • Voltage protection engaged. Voltage to the amp is not within the 10-16.8 VDC operating range. Have the battery/charging system inspected. • Short circuit protection is engaged. Check for speaker wires shorted to each other or the vehicle chassis. Speakers operating below the minimum impedance can cause this to occur.
Alternator noise (varies with RPM)	<ul style="list-style-type: none"> • Check for damaged RCA cable. • Check routing of RCA cable. • Check Source Unit for good ground. • Check amp gain setting, turn down if set too high.
Poor Bass Response	<ul style="list-style-type: none"> • Check speaker polarity, reverse the connection of one speaker only.

***NOTE:** If the RED protection L.E.D. is activated with no speakers connected to the amplifier, and all the power connections are correct, this would indicate an internal problem with the amplifier. Contact SOUND STREAM or your local dealer.*

S●**UNDSTREAM**