

POWER ACOUSTIK®

AV Center

Owner's Manual EN

2-Din Headunit

MP3/MP4/USB/SD/AUX

Built-in AM/FM & Bluetooth

Supports Apple CarPlay™

Supports Android Auto™

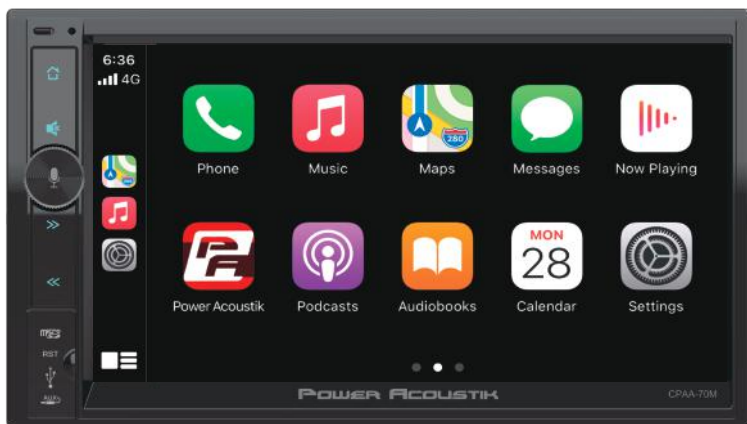

CPAA-70M

INTRODUCTION

Safety Warning and Considerations

- Clean only with a dry cloth or other similar materials.
- Install your product in a dry location that does not interfere with your vehicle's equipment.
- Do not block any ventilation openings when installing this product.
- Do not mount the in the engine compartment of your vehicle or any hot surfaces

- Securely mount the product so that it does not come loose in the event of a collision or as a result of repeated vibrations that might occur during regular operation.
- Installation of the apparatus must be done with great care to prevent damage to your vehicle's fuel lines, power, and electrical wiring, hydraulic brake lines, and other systems. If possible, always visit your nearest Power Acoustik dealer to perform the installation.
- Do not run any wiring outside or underneath the vehicle. Keep all wires inside the car.
- Take the necessary precautions when making connections to the vehicle's battery to avoid any potential shock.
- Protect all system wires from sharp edges by carefully routing them; always use rubber grommets to protect wiring and cables whenever installing them through metal openings.
- Secure all wiring using cable ties or wire clamps to protect them from moving parts and sharp edges.

Refer all servicing to qualified service professionals. Service is required when the head unit has been damaged. Such as the power input terminals are damaged, liquid has been spilled, or objects have fallen into the apparatus, the apparatus has been exposed to rain or moisture, does not operate normally, or has been dropped.

- Fuses shall be replaced only with the correct type and fuse value, and only when the apparatus is powered off.
- Exposure to high sound pressure levels may lead to permanent hearing loss. Take every precaution to protect your hearing.

This product is designed specifically for use with 12V systems only. Using this product in systems with positive ground and/or voltages other than 12V may damage the product and your system.

CONTENTS

- Introduction..... 2**
- Wiring Connection 4**
- Installation & Accessories 5**
- Parking & Speaker connection 6**
- Panel Function Introduction 7**
- Remote Control Introduction..... 8**
- Functions & Applications 10**
 - Basic Operation
 - Main Menu
 - Radio
 - Phone
 - External Play Device
 - Music
 - Settings Operation
 - Aux In
 - Android Auto/Carplay
- Common Trouble-shooting..... 19**
- Specification20**

WIRING CONNECTION

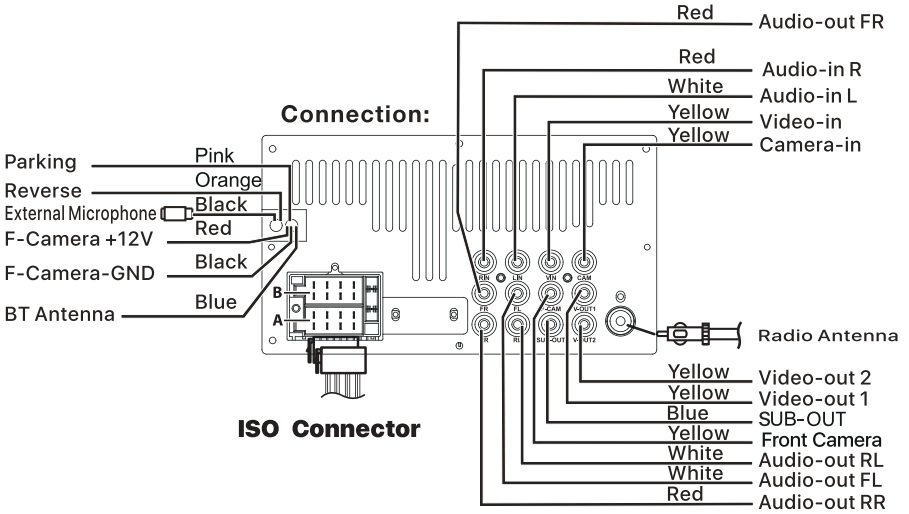

| A | Color | Fuction | B | Color | Fuction |
|---|--------|---------------|---|--------------|---------|
| 1 | Black | SWC-GND | 1 | Purple | RR+ |
| 2 | Green | SWC-KEY1 | 2 | Gray | FR+ |
| 3 | Blue | Power Antenna | 3 | White | FL+ |
| 4 | Red | ACC | 4 | Green | RL+ |
| 5 | Brown | SWC-KEY2 | 5 | Purple/Black | RR- |
| 6 | Yellow | BATT | 6 | Gray/Black | FR- |
| 7 | Orange | ILL | 7 | White/Black | FL- |
| 8 | Black | GND | 8 | Green/Black | RL- |

Fuse: Max. 15 Ampere

Voltage: 12V DC; Negative Ground

INSTALLATION & ACCESSORIES

1. Put the 2 brackets to the left and right side of the headunit.
2. Use screws to attach brackets to the headunit.

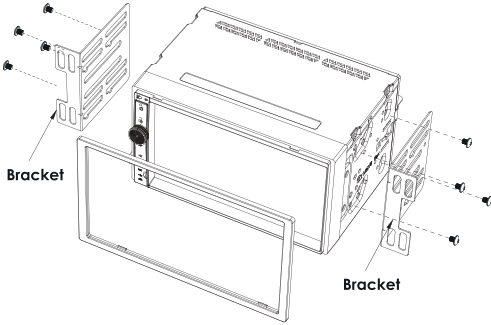







Note:

1. Make sure the ignition is turned off, and disconnect the cable from the vehicle battery's negative (-) terminal. You never want electricity running while you install this 2-DIN car receiver.
2. Before installation, disconnect the wire harness and the antenna.
3. Attach the brackets on the both sides of the car receiver with screws as shown as the figure. Please buy from your dealer according to the drilling of holes size.

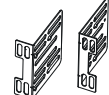
4. Consult with your nearest authorized dealer if installation requires the drilling of holes or other modification of the vehicle.
5. Install the headunit in the dashboard.
6. Connect the wire harness & antenna to the car receiver being carefully not to pinch any wires or cables.
7. Install the plastic outer trim ring if needed onto the headunit.
8. Reconnect the vehicles battery and run through all of the options on this car receiver to ensure that everything is working correctly.
9. Results will vary widely depending upon the kind of your car and the car you intend to install it in. Please choose the correct installation method according to the actual situation of your car. Always contact the car dealer or manufacturer if you have any questions.

ACCESSORIES

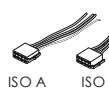
Package contains the following for installation and operation of the unit.

| | | | | | |
|-----------------------|---|---|--------------------|---|---|
| (1) Mounting Brackets | 2 |  | (3) Remote Control | 1 |  |
| (2) Mounting Screws | 8 |  | | | |
| (4) Trim Ring | 1 |  | (5) User Manual | 1 |  |
| (6) Power Harness | 1 |  | (7) Warranty Card | 1 |  |

PARKING & SPEAKER CONNECTIONS:

Note: To watch video the parking wire should be connected to brake signal.

Parking wire

Note: The parking wire is connected with brake signal; for safety, the programs can be seen on the headunits touchscreen.

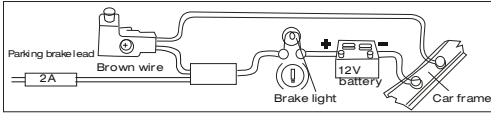

Connecting the reserve signal at taillight on the car (10V+ Required for Signal)

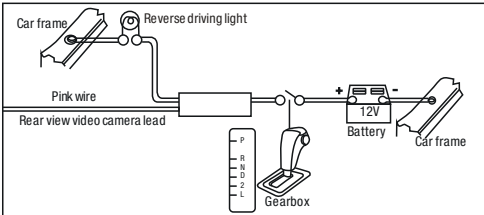

After connecting, when you start up the reverse gear, the unit will receive the picture from car rear view camera.

Speaker Connection

- We Recommend using car speakers with minimum 40Watt potential.
- Headunits potential power may result in damaging your OE speakers at higher volumes.
- Use 4Ω ~ 8 Ω (Ohm impedance) speakers only; using higher or lesser impedance may damage the headunit.
- Speaker cables and/or optional external power amplifiers must always be about 30cm away from the antenna and/or antenna extension parts.
- Do not connect the speaker leads of the power harness to battery; otherwise, the unit will be seriously damaged.
- Before connecting the speaker leads of the harness to the speakers, check the speaker wiring in your car.

Connect the speakers according the following diagram, incorrect connections will damage the unit or your vehicles speakers.

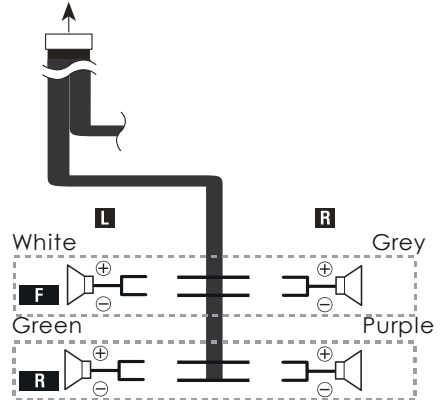

PANNEL FUNCTION INTRODUCTION



- 1. Microphone:** Built-in Microphone.
- 2. Remote Sensor:** Receive the remote signal.
- 3. Home:** Press to enter main menu.
- 4. Mute:** Press to Mute / Unmute.
- 5. Rotary Knob:** When the unit is power off, short press to Power ON
When the unit is working, long Press to Power Off.
Rotate to adjust the headunit's volume.
Short Press to active Siri/AA voice function .
- 6. NEXT:** **Short Press:** [Radio] Switch to the next preset.
[USB/SD] Select next track.
[CP/AA/BT Phone] Select next track.
Long Press: [Radio] - Automatic seek (upward).
[USB/SD] - Fast forward.
- 7. Previous:** **Short Press:** [Radio] Switch to the previous preset.
[USB/SD] Select previous track.
[CP/AA/BT Phone] Select previous track.
Long Press: [Radio] - Automatic seek (downward).
[USB/SD] - Fast rewind.
- 8. Micro SD:** Insert Micro SD for Music/Video Playback.
Reset: If the unit or the connected unit fails to operate properly,
the unit returns to factory settings when this button is pressed.
USB: Insert USB for Music/Video Playback.
AUX: Insert 3.5mm AUX for Audio Playback.

REMOTE CONTROL INTRODUCTION



- 1. Power On/Off:** When the unit is power off, short press to Power ON
When the unit is working, long Press to Power Off.
Short Press: When the unit is working, short press to Mute / Unmute.
- 2. Mode:** Press to switch mode.
- 3. Answer button:** [CP/AA/BT Phone] - Call out /Answer a call.
- 4. Reject button:** [CP/AA/BT Phone] - Reject an incoming call /Hang up the calling.
- 5. VOL+:** Increase volume.
- 6. NEXT: Short Press:** [Radio] Switch to the next preset.
[USB/SD] Next track.
[CP/AA/BT Phone]Next track.
Long Press: [Radio] - Automatic seek (upward).
[USB/SD] - Fast forward.
- 7. Previous: Short Press:** [Radio] Switch to the previous preset.
[USB/SD] Select previous track.
[CP/AA/BT Phone] Previous track.
Long Press: [Radio] - Automatic seek (downward).
[USB/SD] - Fast rewind.

REMOTE CONTROL INTRODUCTION

8. Play/Pause: **Short Press:** Play or Pause.
Long Press: Confirm the selection.

9. VOL-: Decrease volume.

10. Siri: Press to active Siri/AA voice function (When the iPhone/Android phone is connected).

11. CP/AA: Press to enter CarPlay™ / Android Auto™ directly (When the iPhone/Android phone is connected).

12. Number: [1-6] (AM/FM) , press any one of the number key 1-6 to select a station that had been stored in the preset memory number key 1-6 for broadcasting.
[0-9] (USB/SD) , press directly to input the number of track for playback.
[0-9,*,#] (Phone) , press directly to input the number for dial out.

Note: BT Phone - Long press the button "7" to input the content " * ";
Long press button "9" to input the content "#";
Long press "0" to input the content "+".

FUNCTIONS APPLICATION

Basic Operations

Main Menu

Please refer to the actual menu display for reference.

During initial power on, the unit will show the languages setting interface, select the required country and language, then press “√” to enter the main menu.



Radio: Shows the Radio interface.
Phone: Shows the Bluetooth interface.

Android Auto™/CarPlay™ : Shows the relevant interface based on your connected device.

USB: Shows the USB playback interface for compatible files.

BT Music: Shows the BT music playback interface.



F-camera: Turn on the front camera.

Setting : Shows the Settings interface.

AV-In: Shows the AV-IN interface.

Card : Shows the TF Card interface, enabling playback for compatible files.

ScreenOff: Turns off the screen, to reactivate the screen simply press any part of the screen.

Radio

Touch “Radio” in the main menu to enter the AM/FM radio interface.



[Home] To return to the main menu.

[Radio Waves] Switch between FM1/FM2/FM3 /AM1/AM2.

[EQ] Enter the EQ settings interface.

[Radio Tower] Switch LOCAL or DX.

[Grid] Shows the Radio tuning input interface, input the frequency directly or selected preset stations to start playing.

[Magnifying Glass] Short press to browse the stored Preset stations.

Long press to automatically search and save stations with the strongest signals into the presets.

FUNCTIONS APPLICATION

【◀◀】 Short press to search backward for stations automatically, Long press to step back.

【▶▶】 Short press to search forward for stations automatically, Long press to step.



RDS Function

RDS will allow you to display information such as traffic status, radio station name and more. The unit can automatically switch to the strongest station based on the similar program.

TA: "TA" is displayed during a switched-through traffic announcement.

PTY: Shows program types, and allows you to search for stations according to different programs as below:







Phone

This unit allows for hands free calling, using your phone's Bluetooth connection to the unit, you'll be able to dial, answer, access phone book and playback music.

Enter the Bluetooth interface using the Bluetooth button.



-  Keyboard, enter call mode.
-  History, show the call record, missed, received and dialed calls
-  Phone book, show the phone-book connected phone
-  Setup

Pair/Connect

Connect your phone to the unit using the below steps.

1. Access the Bluetooth connection interface in your phone.
2. Search for Bluetooth devices from either the unit or phone.
3. The device will pop up the pairing code and click "pairing" to complete the connection.



FUNCTIONS APPLICATION

No Pair:



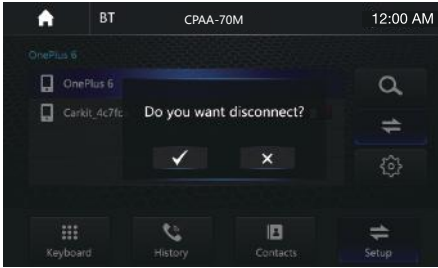

Paired:







-  Search the available devices.
-  Manage the connected device.
-  Set auto answer and load phone book.

Dial

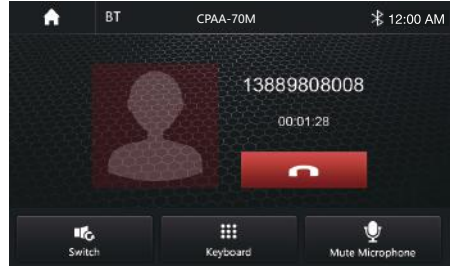
Once the phone and unit are connected successfully, you'll be able to make calls from the unit. Touch  to make a call.



Touch  to delete numbers one by one, long press to delete all inputted numbers.



Touch  to show the numbers keyboard, touch again to exit. Touch  to hang up the call. Touch  to switch call audio to phone or AV receiver. Touch  to mute.

Receive an incoming call



-  Answer the incoming call.
-  Reject the incoming call.

FUNCTIONS APPLICATION

Note: You can also manage calls through your phone.

Calling Record

Check for dialed/answered/missed calls history. Touch  icon to enter calling record interface:

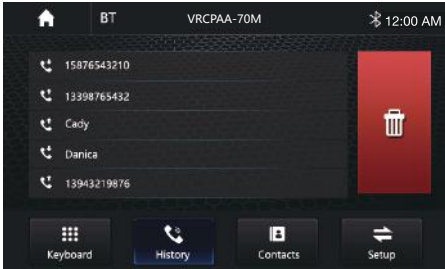

: Delete desired calls.

Phone Book



When your phone and unit are paired, the unit can automatically reach contacts from your phone and store them within the unit. (selected phones only)

: Delete Contacts.

BT Setup



BT Switch the BT function is On or Off .

“Auto Answer”, Incoming call auto answer.

“Auto Loadpbk”, On /OFF, when connect phone auto load phonebook on or off. **“Loadpbk”**, Manually load phonebook.

12:00 AM

Bluetooth Audio Playback

Touch  to enter music interface.



- 1
- 2
- 3
- 4

1. Play previous song.
2. Play/pause current song.
3. Play next song.
4. EQ settings

FUNCTIONS APPLICATION

External Play Device

When you connect a compatible data device to your unit, the following interface will appear.

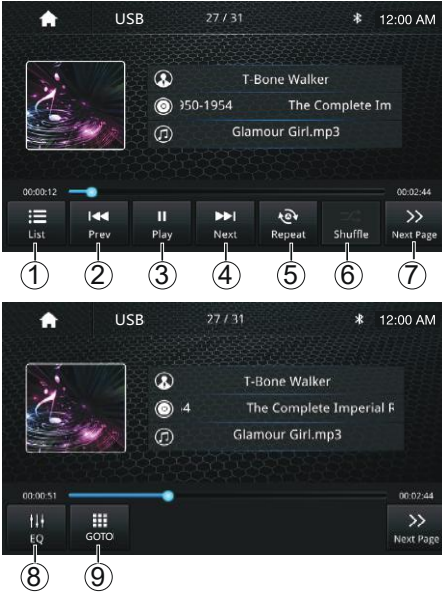



1. USB List Menu
2. Short press: Play previous song/ media.
Long press: Fast reverse.
3. Play/pause current song/media
4. Short press: Play next song/ media.
Long press: Fast forward.
5. Repeat mode
Repeat all - Repeat off - Repeat single
6. Random playback on/off
7. Next page
8. EQ settings
9. Numbers selection playback

File List browsing

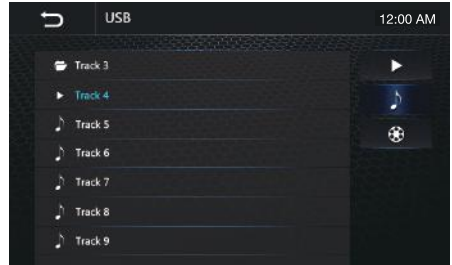
Touch  to browse the folder and file list of the USB device. You can select the multi-media type



-  Return to playing previous file.
-  Select Audio or Music files.
-  Select Movie or Video files.

Video playback



1. Magify the display screen.
2. Adjust the display brightness.

FUNCTIONS APPLICATION

Settings Operation

Touch “” icon from main menu to enter the settings interface.

Time Setting

Touch “time” to enter time setting
Up/down sliding can set Year/
Month/Day/Hour/Minute/Model.
Up/Down sliding to select the
desired selection.



Sound Setting

Touch “Sound Setting” to enter
sound setting interface:



BEEP: Switch the Beep is On /Off.
Reverse Vol: Adjust the Vol 0-20.



EQ:

Fader / Balance:

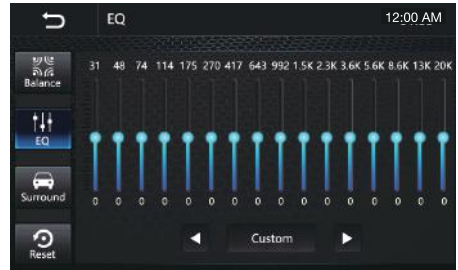

LOUD: Switch the Loud is On /Off.
Fader: Adjust the fader F7-R7.
Balance: Adjust the balance L7-R7.



 : Select desired equalizer:
Standard>Custom>Classic>
Rock>Jazz>Electric>Pop>Soft
In Custom, can adjust the 16-band
frequency gain -7 - +7.

Surround:



: Reset to default settings.

FUNCTIONS APPLICATION

Subwoofer:



Subwoofer: Switch the Subwoofer is On /Off.

Subwoofer Frequency: Select 50Hz>80Hz>120Hz>160Hz

Subwoofer Level: Adjust the value -12-+12.

Volume Control:



Set the Main / BT Talking /Navi / Voice default volume value.

General Setting

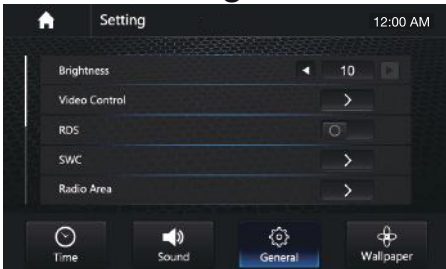

Brightness

:Adjust the screen's brightness from 1-10.

Video Control:

Touch the icon to set the brightness and contrast of the screen.
Touch Reset to default settings.

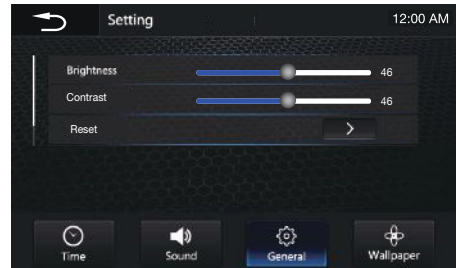

RDS: Switch the RDS is On /Off.

FUNCTIONS APPLICATION

SWC: Touch “SWC” icon to enter the steering wheel control menu.



Short time press the key of the car radio SWC screen first and then long time press corresponding button of car steering wheel for learning and setting .

Note: Press the “Reset” before you start the setting.

Radio Area: Choose the required radio region.

America / Europe / Eastern Europe / Japan / Southeast Asia /Latin America / South America / Asia/ Australia.

Serial/Version: Touch the icon to enter serial number and version number interface, to check the needed information.

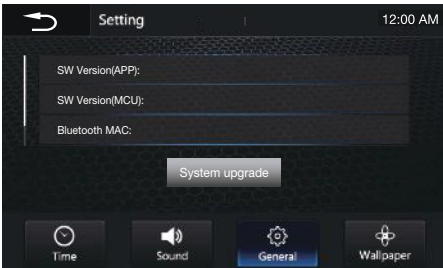

Language: Touch the icon to enter language setting interface, select the required language.

Reset Factory Data

Once selected, the unit will prompt to confirm reset to factory settings. Once confirmed the system will automatically reboot.

MIC Switch: Touch  icon to change front or rear external mic.

Note: External Microphone is exclude.

Driver Position: Touch  icon to select the driver position is Left or Right.

Note: If you select right driver position, the Apple CarPlay UI will be change to right mode.

Driver Forbidden Watch video: Touch the icon to turn ON/OFF the Driver Forbidden Watch video

Seven Colour Light: Touch the icon to adjust the brightness mode and relevant functions.

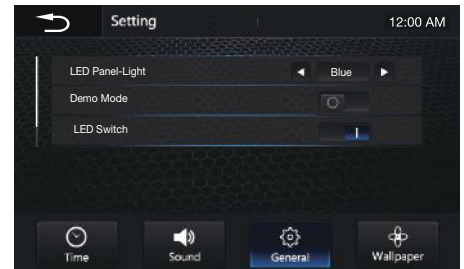

LED Panel-Light: Touch  icon to select required LED light color: RED/ YELLOW/GREEN/BLUE/PURPLE /CYAN/WHITE.

FUNCTIONS APPLICATION

Demo Mode: Touch to switch Demo Mode is On or Off. The panel Led will change automatically cycling.

LED Switch: Touch to switch the panel Led is On or Off.

Wallpapers Setting

Choose the required wallpaper, touch "wallpaper setting" icon to enter the setting interface.

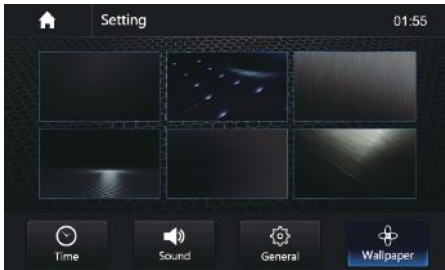

AV In

Insert video input connector to input video's input jack, audio input conencto to input audio's input jack, touch "AV-IN" icon from main menu to enter the AV IN interface.

AUX In

Insert AUX input connector to AUX jack onto front panel. Touch "AUX-IN" icon from main menu to enter the AUX IN interface.

Android Auto™/CarPlay™

Connect Android Smartphone to the unit to enter the Android Auto™ interface.

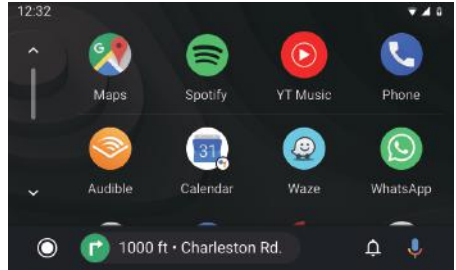

The unit can be used to call, play music, view maps, check traffic information, return to the unit's main interface, listen to Podcasts, read Audiobooks and so on.

Connect iPhone to the unit to enter the CarPlay™ interface.

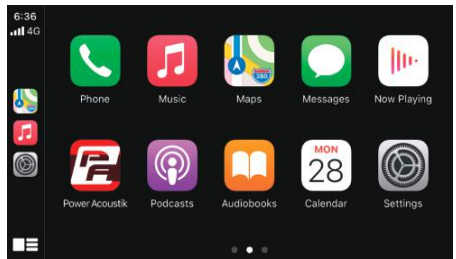

The headunit can be used to make calls, play music, view maps, check traffic information, return to the unit's main interface, listen to Podcasts, etc.

COMMON TROUBLE-SHOOTING

| Problem | Cause | Correct action |
|---|--|--|
| Cannot power on | Check fuse | Replace fuse |
| | Other factors causing MPU to malfunction | Press RES button on the panel using a sharp point then power on |
| After ignition switch off, setting information are lost | Change battery or fuse | Reset information and save |
| Poor performance of radio station | Weak signal | Move the car to another place, then try again |
| No Picture/Image | Other factors causing MPU to malfunction | Press RES button on the panel by penpoint, then, power on |
| Cannot watch video during driving | Video viewing is not allowed during driving. | Park the car in, put the car in "P" position, pull up the hand brake, parking brake wire must be grounded. |

SPECIFICATION:

General

| | |
|----------------------------|----------------------------|
| Power Supply..... | DC10-16V |
| Grounding System..... | Negative Ground |
| Current Drain..... | 15A(Max.) |
| Speaker Impedance..... | 4 ohm per channel |
| Frequency Response..... | 20Hz~20kHz |
| Operating Temperature..... | -20~+60 C |
| Dimensions..... | 178mm(W)x125mm(D)x100mm(H) |

TFT Display

| | |
|----------------------|-----------------|
| TFT Screen Size..... | 7 inch |
| Resolution..... | 1024x600 Pixels |

FM Radio

| | |
|------------------------------------|---------------|
| Frequency Range(USA)..... | 87.5~107.9MHz |
| Frequency Range(Europe)..... | 87.5~108.0MHz |
| Enable Sensitivity (S/N=30dB)..... | ≤15dB |
| SN Ratio..... | ≥55dB |
| Stereo Separation..... | ≥30dB |

AM Radio

| | |
|------------------------------------|-------------|
| Frequency Range(USA)..... | 530~1710KHz |
| Frequency Range(Europe)..... | 522~1620KHz |
| Enable Sensitivity (S/N=20dB)..... | ≤40dB |
| SN Ratio..... | ≥45dB |

Line-out / Subwoofer Output

| | |
|--|---------|
| Maximum Output Level (10Kohms load)..... | ≥4V rms |
| Subwoofer Output Level..... | ≥4V rms |

